

myone



E N G L I S H C A T A L O G U E



Made in Italy

myone



MYONE

Myone, which joined the Benincà group in 2013, is the go-to company for solutions for automatic pedestrian doors. It is supported by the group's cutting-edge research and development department in designing products and systems to improve the mobility of things and people. Its products, which are aimed at professionals, can also meet end users' requirements for ease of use and technological innovation and design.



100%
Made in Italy

All the Myone systems are made entirely in Italy with rigorous control of the components and the manufacturing process, a system of excellence that marks all the Benincà group companies and guarantees the safety and reliability of our products.



safety
and compliance

Regulations for automatic gates and opening are becoming increasingly strict. Manufacturers have to develop systems that are compliant with directives and make entrances safe. All the Myone operators meet EN16005 standards and are CE-certified.



ONLINE SERVICES



www.myoneautomation.com

Myone offers solutions for installers, window manufacturers, and designers.

Every client needs help in choosing the right automation. That's why providing them with all the information possible is essential. To make our website more user-friendly, we divided it by product ranges and added symbols defining

the various areas. We decided to make some information available to everyone and create a reserved area where professionals can find tools and documentation.



What information is always available on the website?

- The full version of the catalogue
- Product sheets
- Instructions
- CE certifications

Moreover, every product is illustrated to highlight its functions, technical data, overall size, and models available.

What can a professional find in the reserved area?

- Firmware update
- Technical files
- Assembly instructions
- DWG diagrams
- Spare part lists
- Configurator

This section provides all the documents needed for designing, installing, standardising, and updating (firmware) the system. Moreover, clients can use another useful tool, i.e., the configurator.



ONLINE CONFIGURATOR

Understanding which is the right product in terms of automation, fixtures, or automation for fixtures is essential.



Myone's configurator can guide users step-by-step in choosing the ideal solution for any type of passage. The aim is to obtain complete configurations that can be saved in the user account allocated to the clients in the contact list. In addition, these configurations can be customised by adding items or dedicated discounts, thus becoming accurate quotes.

Moreover, the configurator provides a precise list of accessories and items necessary to complete the chosen configuration. If the passage configuration includes fixtures, the system returns an accurate cutting list that can be forwarded to the company as a pre-order.

Among the services offered by the company and mentioned in the configurator, there is also the possibility to customise the colour of the automation cover, by choosing among the available RAL colours.



THE MYONE RANGE

a product for every need

Myone offers operators suitable for every type of entrance or use, which can meet restrictions relating to the aesthetic or architectural impact of the door as well as manage openings with intensive use

and in harsh environmental conditions. The company can also offer a range of door frames so that customers have complete solutions for every situation.

automatic sliding doors



standard sliding doors



telescopic sliding doors



compact sliding doors



redundant sliding doors



watertight sliding doors



certified watertight sliding doors for use in water

automatic swing doors



swing doors with motor-driven closing system



swing doors with spring closing system

aluminium door frames



set of components for sliding doors



aluminium profiles

technical solutions

Myone operators are distinguished by technical solutions that make professionals' work easy and guarantee maximum resistance and strength.

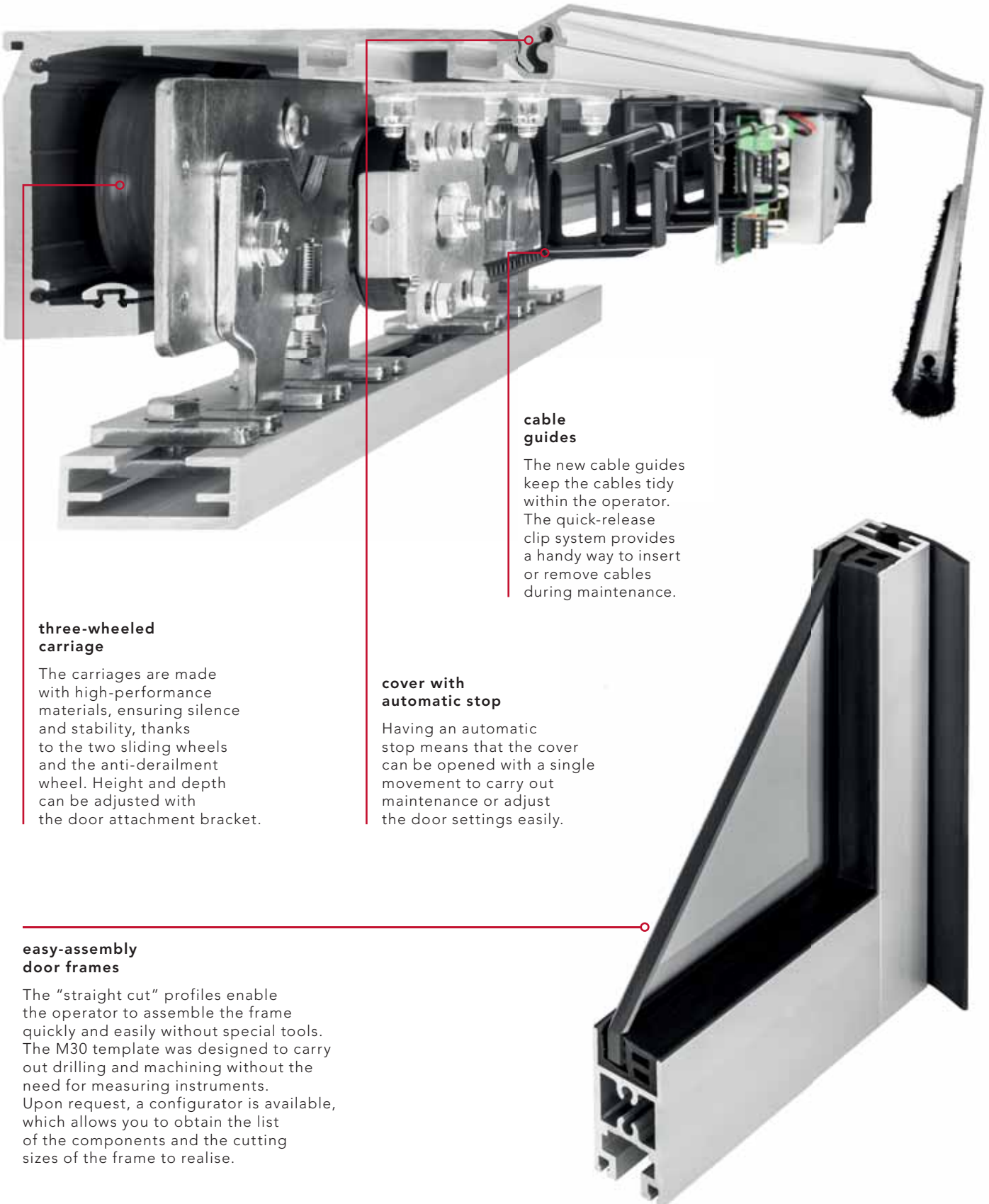

three-wheeled carriage

The carriages are made with high-performance materials, ensuring silence and stability, thanks to the two sliding wheels and the anti-derailment wheel. Height and depth can be adjusted with the door attachment bracket.

cable guides

The new cable guides keep the cables tidy within the operator. The quick-release clip system provides a handy way to insert or remove cables during maintenance.

cover with automatic stop

Having an automatic stop means that the cover can be opened with a single movement to carry out maintenance or adjust the door settings easily.

easy-assembly door frames

The "straight cut" profiles enable the operator to assemble the frame quickly and easily without special tools. The M30 template was designed to carry out drilling and machining without the need for measuring instruments. Upon request, a configurator is available, which allows you to obtain the list of the components and the cutting sizes of the frame to realise.



ADVANCED ELECTRONICS

Myone products have developed into a range of operators using unique and particularly innovative electronics. The various features have been extended to all models creating strategic uniformity as well as simplifying the professional's work to install, wire and maintain the systems.

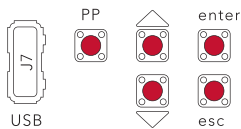

The new electronic system has a LED alphanumeric display that can be configured with a four-level menu, making programming very easy.

- bRSE** basic parameters
- InFo** information about the board
- REn** storage or reading operations on USB drive
- Rdu** advanced parameters



The wide-range switching power supply ensures greater energy efficiency and optimal operation at all times, especially if there are voltage peaks. The operator will work even during a power cut through the integrated battery charger board. The battery kit is inserted inside the operator ensuring a high level of aesthetic cleanness.



Every 24 hours the control unit performs a test to check the presence of the batteries and the level of charge; these checks make it possible to find and monitor any malfunctions.



There are many operating logics and customisable parameters. The self-calibration function makes installation easy, as the operating parameters are automatically adjusted during initial installation. Wiring is made even easier and more intuitive thanks to removable coloured terminal blocks.



The presence of a USB connector on the control unit makes it quick and easy to update the operator firmware, as well as enabling the installer to download data pertaining to operating parameters and log files describing errors onto a flash drive.

Being able to download the operating parameters is very valuable if you want to copy the data used in a recent installation to another one. You just need to download the operating parameters and data using the flash drive and use them to program the new automatic door simply and immediately. The control unit also has a "menu protection" function which prevents third-party actions and tampering.



INDEX

14

GUIDE FOR CHOOSING

16

STANDARD SLIDING DOORS

LUCE LIGHT

- 19 - preassembled
 - 20 - kit for one-leaf sliding doors
 - 21 - kit for two-leaves sliding doors
 - 22 - framed door accessories
 - 22 - glass door accessories
 - 23 - accessories
 - 24 - operator technical drawings
-

28

STANDARD SLIDING DOORS

LUCE HEAVY

- 31 - preassembled
 - 32 - kit for one-leaf sliding doors
 - 33 - kit for two-leaves sliding doors
 - 34 - framed door accessories
 - 34 - glass door accessories
 - 35 - accessories
 - 36 - operator technical drawings
-

40

TELESCOPIC SLIDING DOORS

LUCE T

- 43 - preassembled
 - 44 - framed door accessories
 - 44 - glass door accessories
 - 45 - accessories
 - 46 - operator technical drawings
-

50

COMPACT SLIDING DOORS

LUCE S

- 53 - preassembled
 - 54 - kit for one-leaf sliding doors
 - 55 - kit for two-leaves sliding doors
 - 56 - framed door accessories
 - 56 - glass door accessories
 - 57 - accessories
 - 58 - operator technical drawings
-

62

REDUNDANT SLIDING DOORS

LUCE R

- 65 - preassembled
 - 66 - framed door accessories
 - 66 - glass door accessories
 - 67 - accessories
 - 68 - operator technical drawings
-

72

WATERTIGHT SLIDING DOORS

LUCE WORKS

- 75 - preassembled
 - 76 - kit for one-leaf sliding doors
 - 77 - kit for two-leaves sliding doors
 - 78 - framed door accessories
 - 78 - glass door accessories
 - 79 - accessories
 - 80 - operator technical drawings
-

84

**CERTIFIED
WATERTIGHT
SLIDING DOORS
FOR USE IN WATER**

LUCE WORKS P

- 87** - preassembled
 - 88** - framed door accessories
 - 88** - glass door accessories
 - 89** - accessories
 - 90** - operator technical drawings
-

94

**SWING
DOORS**

ARIA

- 98** - accessories
 - 99** - operator technical drawing
-

100

**SLIDING AND SWING
DOOR ACCESSORIES**

- 102** - sensors
 - 103** - selectors and controls
 - 103** - receivers
 - 103** - transmitters
 - 104** - safety
 - 105** - support beam
-

106

**ALUMINIUM
DOOR FRAMES**

- 108** - set of components for sliding doors
 - 110** - aluminium profiles
 - 111** - gaskets and brushes
 - 111** - assembly components
-

112

GALLERY

116

BENINCÀ GROUP

118

**TERMS AND
CONDITIONS OF SALE**

120

OFFERING GUIDE



GUIDE FOR CHOOSING



automatic sliding door operators

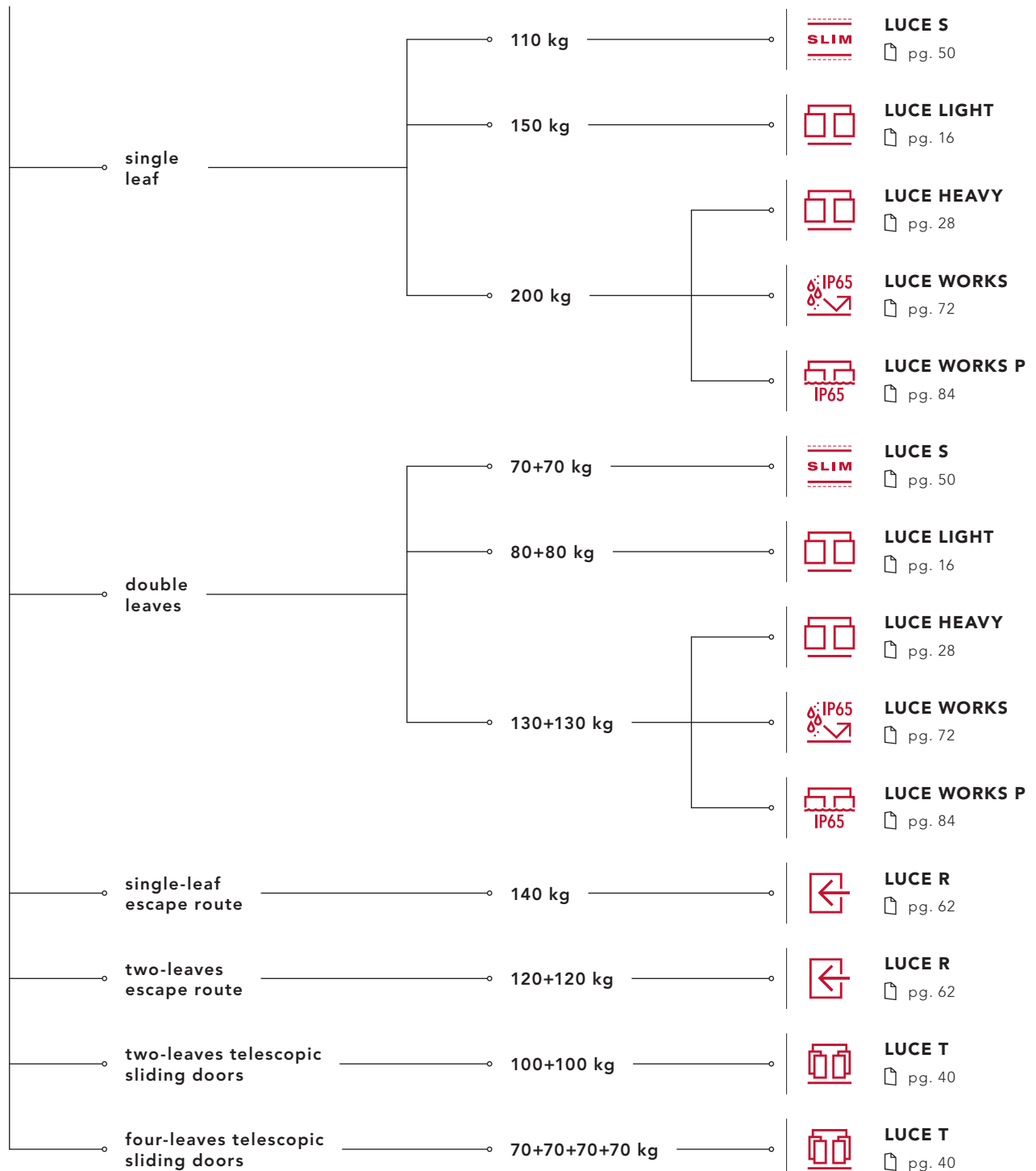



automatic swing door operators

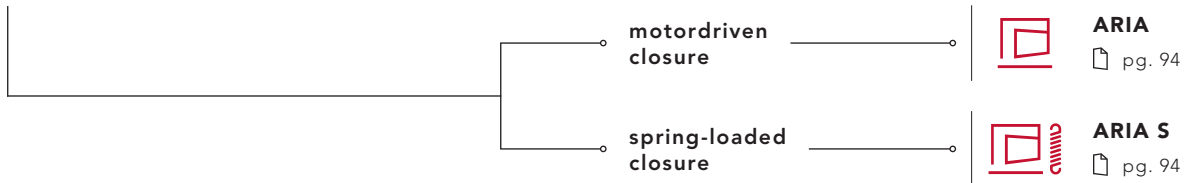

sliding and swing door accessories

pg. 100

- SENSORS**
- SELECTORS AND CONTROLS**
- RECEIVERS**
- TRANSMITTERS**
- SAFETY**
- SUPPORT BEAM**



complete set of door frames

pg. 108

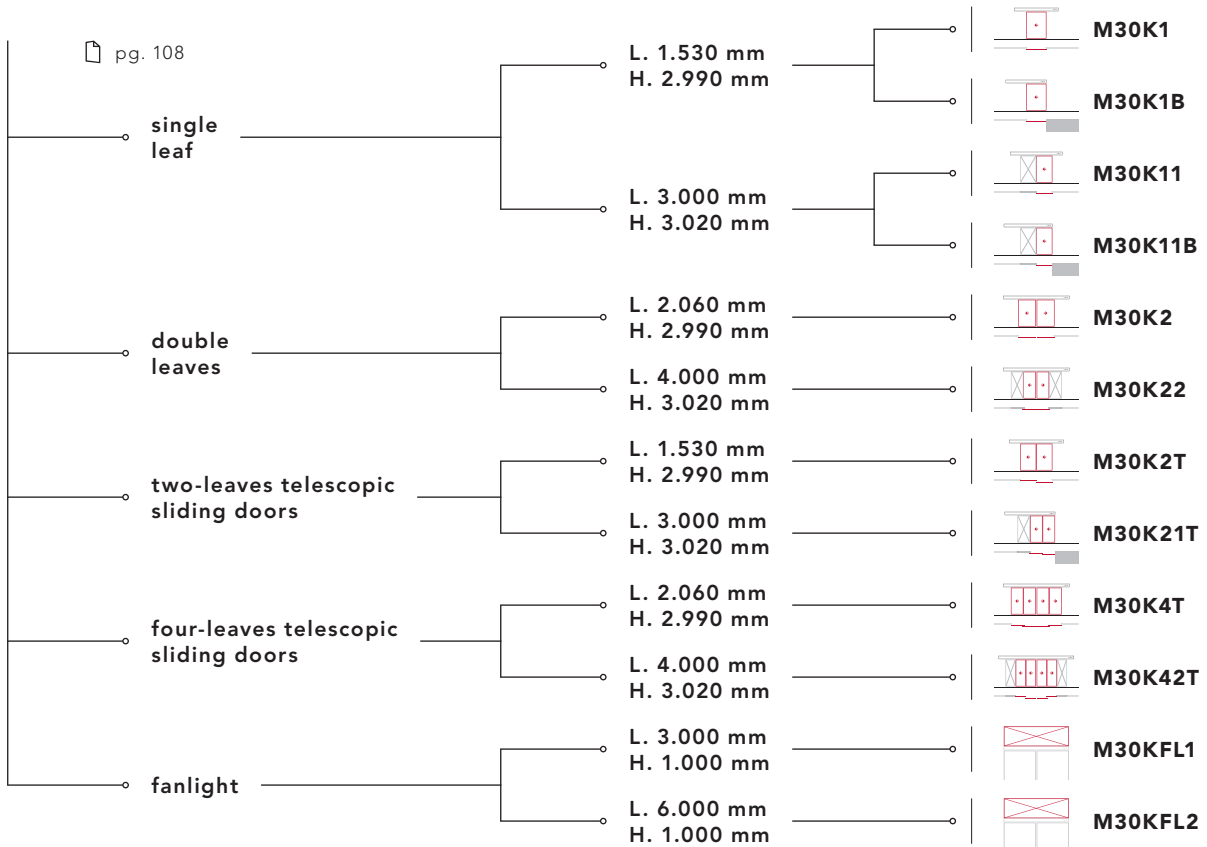

aluminium door frames

pg. 110



LUCE LIGHT



standard sliding doors

The Luce Light sliding doors are the ideal solution for automated pedestrian access points in private and public locations: offices, shops and commercial businesses in general. Fast and easy to install, with continuous operation, they offer top performance and reliability. Available in single-leaf (up to 150 kg) or double-leaf (up to 80+80 kg) versions.



LUCE LIGHT



download LUCE LIGHT
instructions
and certificates

www.myoneautomation.com

Operator for sliding doors with three-wheeled carriages, which ensures that the doors are very stable and easy to adjust, both in height and depth.

The operator has a control unit with LED alphanumeric display, full-range switching power supply (100-240 V 50/60 Hz) and battery charger. The presence of a USB connector makes it simple and quick to update the firmware as well as to copy parameters and operating logics to a new system instantly. Continuous operation guaranteed.

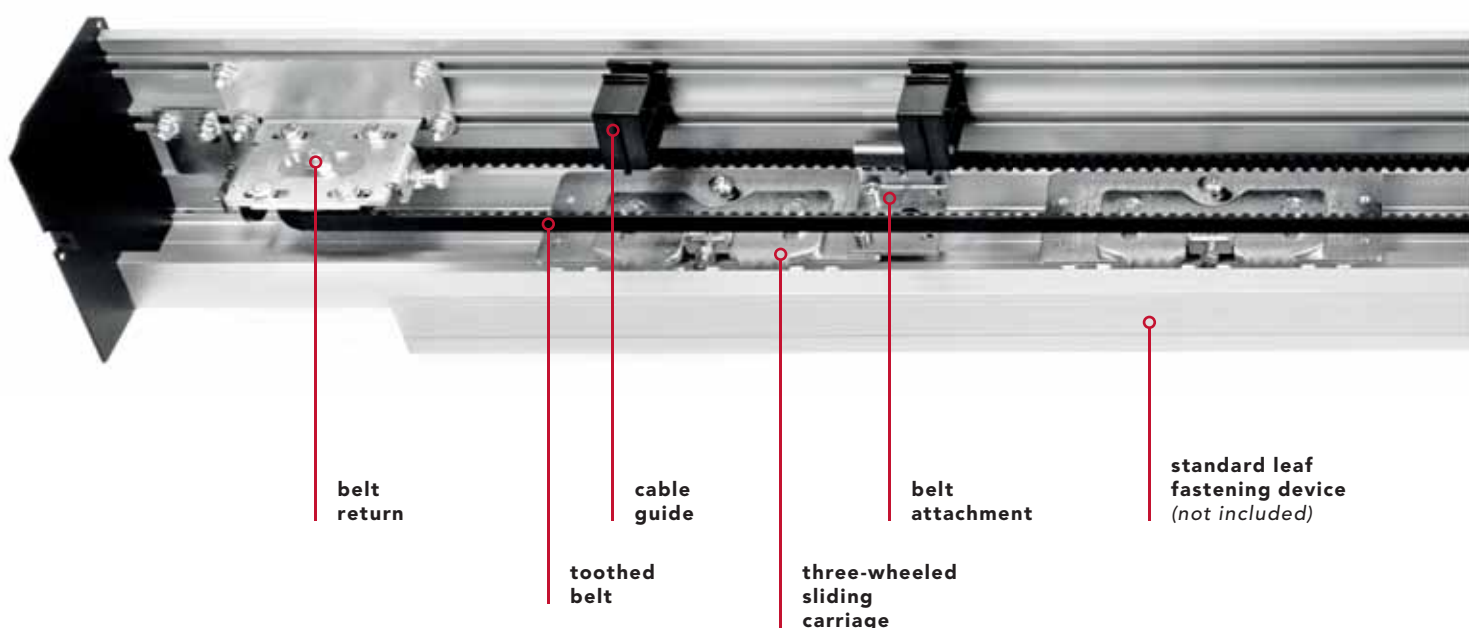

technical data

power supply	full range 100÷240 Vac 50/60 Hz
power consumption	70 W
power consumption in stand-by	3 W
accessories power supply	24 Vdc = / 1 A max
maximum speed 1 door	0.8 m/s
maximum speed 2 doors	1.6 m/s
maximum load 1 door	150 kg
maximum load 2 doors	80 + 80 kg
type and frequency of use	continuous operation = 100%
operating temperature	-15°C / +50°C
protection degree	IP20
data backup memory	USB flash drive



1 leaf
max. weight
150 kg



2 leaves
max. weight
80 + 80 kg



preassembled sliding doors

*The values of the passage size (A) and of the leaf are indicative and include an overlap of around 50 mm.

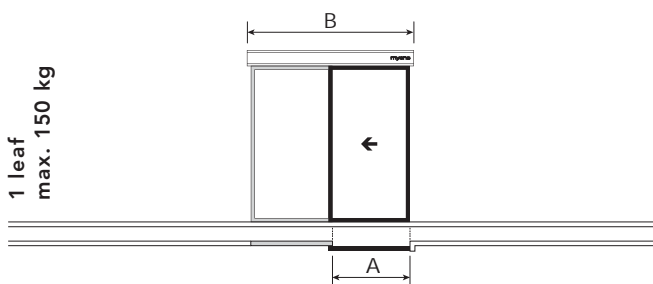

1 leaf
max. 150 kg

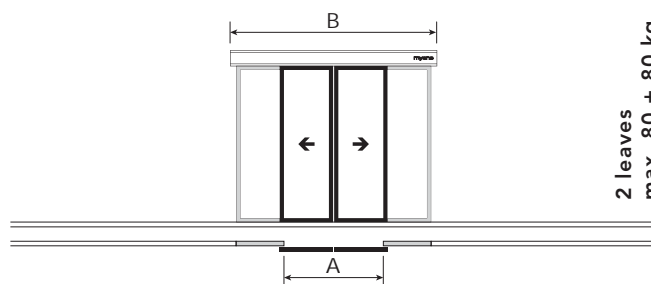

2 leaves
max. 80 + 80 kg

	A	B
LUCEL1901	900 mm	1900 mm
LUCEL2101	1000 mm	2100 mm
LUCEL2501	1200 mm	2500 mm
LUCEL2901	1400 mm	2900 mm
LUCEL3301	1600 mm	3300 mm
LUCEL3701	1800 mm	3700 mm
LUCEL4201	2000 mm	4200 mm
LUCEL5001	2450 mm	5000 mm
LUCEL6501	3100 mm	6500 mm

	A	B
LUCEL1902	900 mm	1900 mm
LUCEL2102	1000 mm	2100 mm
LUCEL2502	1200 mm	2500 mm
LUCEL2902	1400 mm	2900 mm
LUCEL3302	1600 mm	3300 mm
LUCEL3702	1800 mm	3700 mm
LUCEL4202	2000 mm	4200 mm
LUCEL5002	2450 mm	5000 mm
LUCEL6502	3100 mm	6500 mm

the preassembled operator is made up of:

control unit | gear motor with encoder | three-wheeled sliding carriages | supporting profile | anodised aluminium cover | belt return | mechanical stop | belt | cable guide | screw kit | lateral sides



kit for doors with one sliding leaf

KLUC01

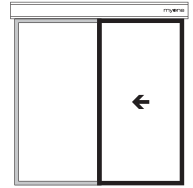

gear motor with encoder and electronic control unit



belt return



cable guides



three-wheeled sliding carriages



mechanical limit switch



belt connection



lateral sides



screw kit



LUCE LIGHT - accessories to complete the kit



01AL0021 - 4,2 m
01AL0022 - 6,5 m

Raw aluminium supporting profile with anodised sliding guide and gasket.
- 2,95 kg/m



01AL0006 - 4,2 m
01AL0023 - 6,5 m

Anodised aluminium cover.
- 1.52 kg/m



32CG0001 - 50 m
32CG0004 - 1 m

Belt.



01IM0007

Packaging kit with headers.



kit for doors
with two sliding leaves

KLUCE02

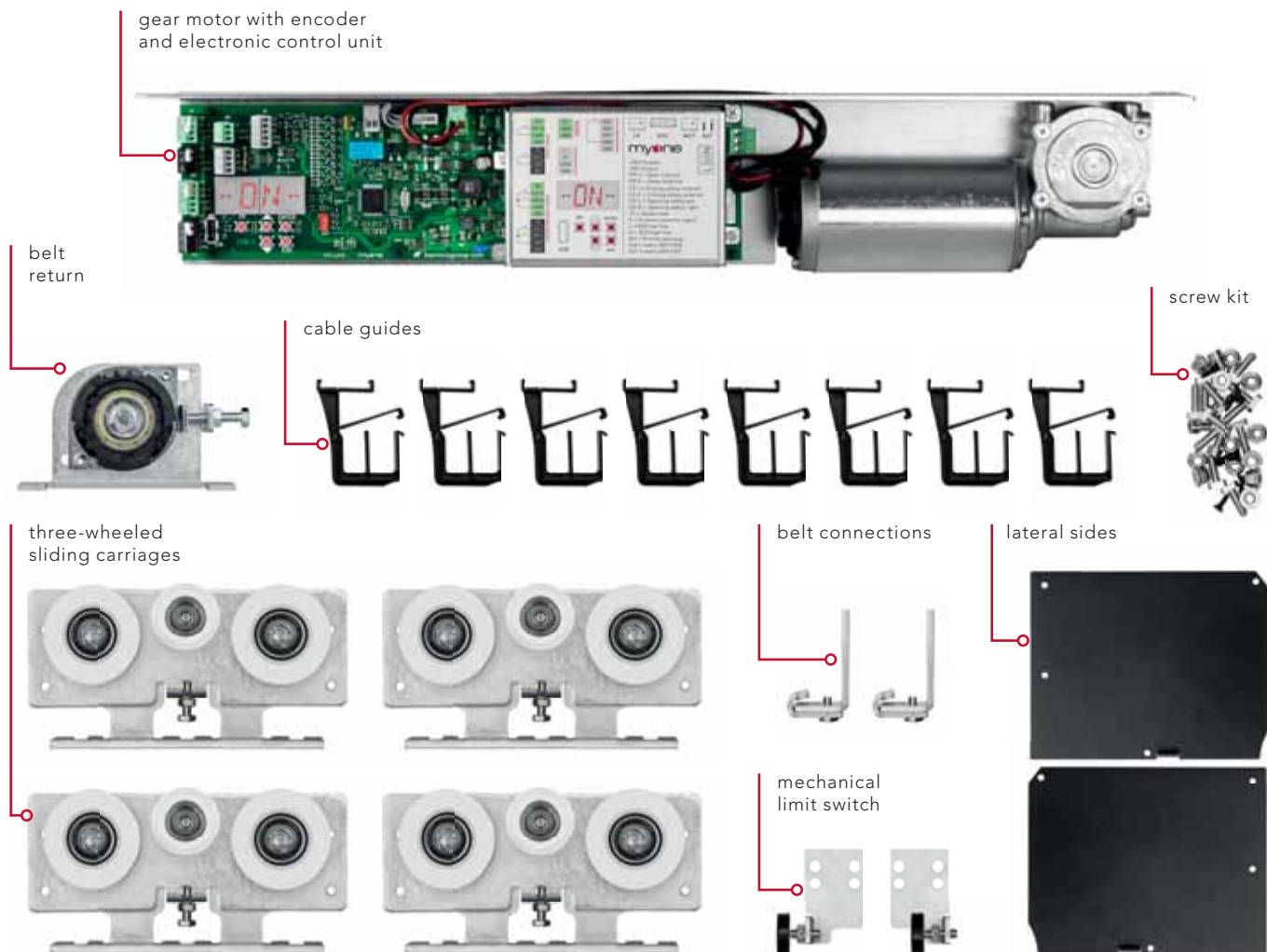
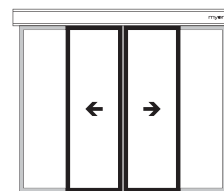

LUCE LIGHT - accessories to complete the kit



01AL0021 - 4,2 m
01AL0022 - 6,5 m

Raw aluminium supporting profile with anodised sliding guide and gasket.
- 2,95 kg/m



01AL0006 - 4,2 m
01AL0023 - 6,5 m

Anodised aluminium cover.
- 1.52 kg/m



32CG0001 - 50 m
32CG0004 - 1 m

Belt.



011M0007

Packaging kit with headers.



discover the Myone frame range

pg. 106

framed door accessories - commercial frame

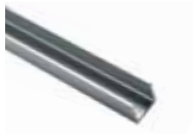

01AL0030 - 1000 mm
01AL0031 - 1500 mm
01AL0032 - 2000 mm
01AL0035 - 3000 mm

Aluminium floor guide for one leaf.



01FE0018

Floor guide slider.



01AL0008 - 1000 mm **01AL0015** - 3000 mm
01AL0009 - 1500 mm **01AL0016** - 5670 mm
01AL0010 - 2000 mm **01AL0020** - 6500 mm

Standard leaf fastening device complete with fixing brackets for the carriage.



90RM0053

Pair of leaf fixing brackets (1 leaf).

glass door accessories - fastening set for glass leaves with pre-drilled holes



99AC0004 - 1000 mm **99AC0016** - 3000 mm
99AC0005 - 1500 mm **99AC0021** - 5670 mm
99AC0006 - 2000 mm **99AC0029** - 6500 mm

Fastening set for glass leaf (10-12 mm) with pre-drilled holes.



01FE0049

Glass door slider.
- 6 piece pack



01FE0050

Glass door stainless steel slider.



01GM0001

Adhesive gasket for glass leaf.
- 6 m pack

glass door accessories - fastening clamp set for glass leaves



99AC0001 - 1000 mm **99AC0014** - 3000 mm
99AC0002 - 1500 mm **99AC0015** - 5670 mm
99AC0003 - 2000 mm **99AC0027** - 6500 mm

Fastening clamp set for glass leaf (10-12 mm thickness).



01FE0049

Glass door slider.
- 6 piece pack



01FE0050

Glass door stainless steel slider.



01GM0001

Adhesive gasket for glass leaf.
- 6 m pack

accessories



99BA0003
Emergency battery kit with wiring and bracket.



99EB0001
Electromechanical lock kit with release cord.



99EB0003
Emergency electromechanical lock kit with release cord.



99EB0006
Electromechanical lock kit for return with release cord.



99AE0001
Opening device with elastic to be used with 99EB0003 electromechanical lock.



01FE0059
Safe for external release.

 other accessories available on page 100

operator cross-section
technical drawing

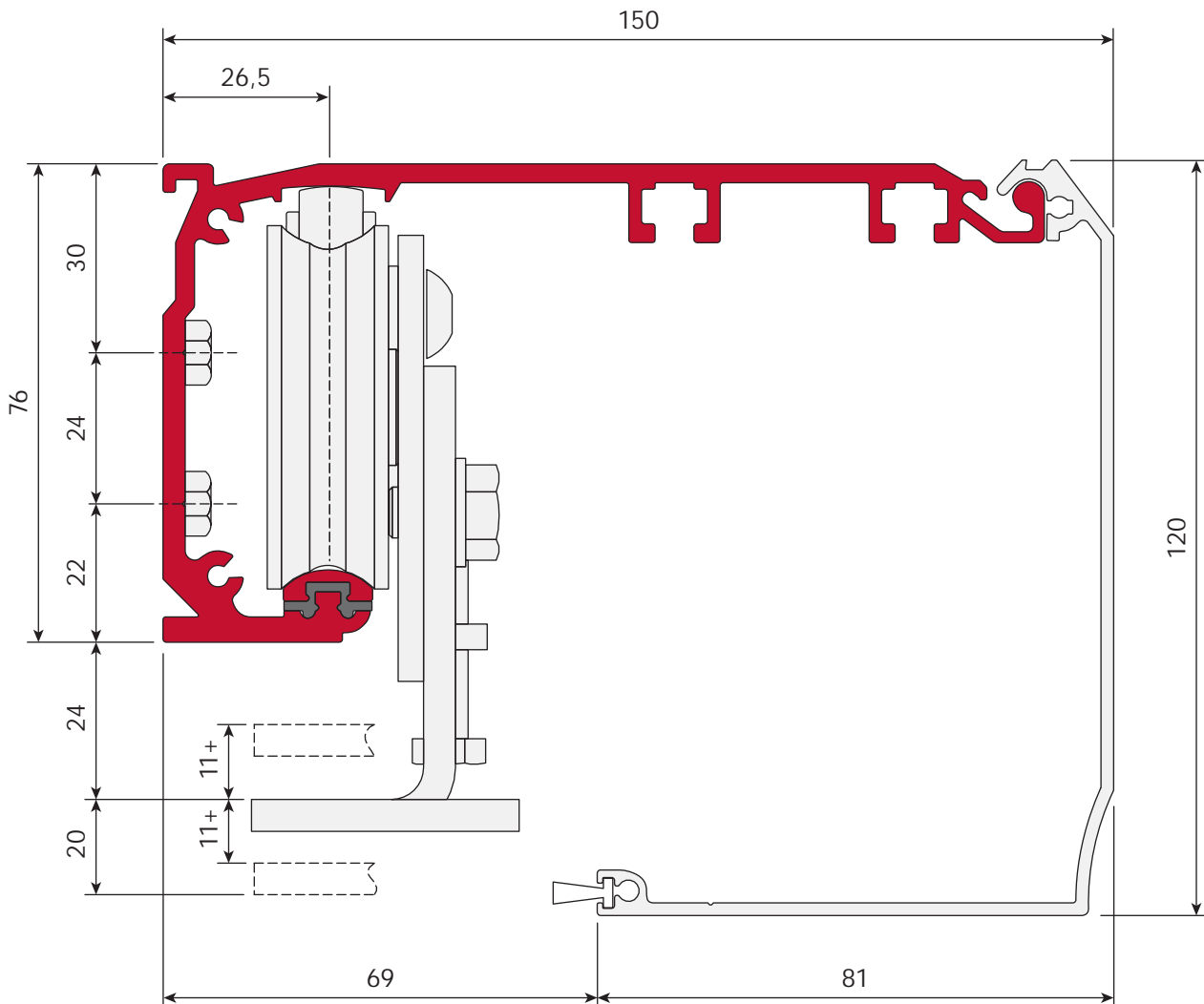



entrance with M30 myone frame

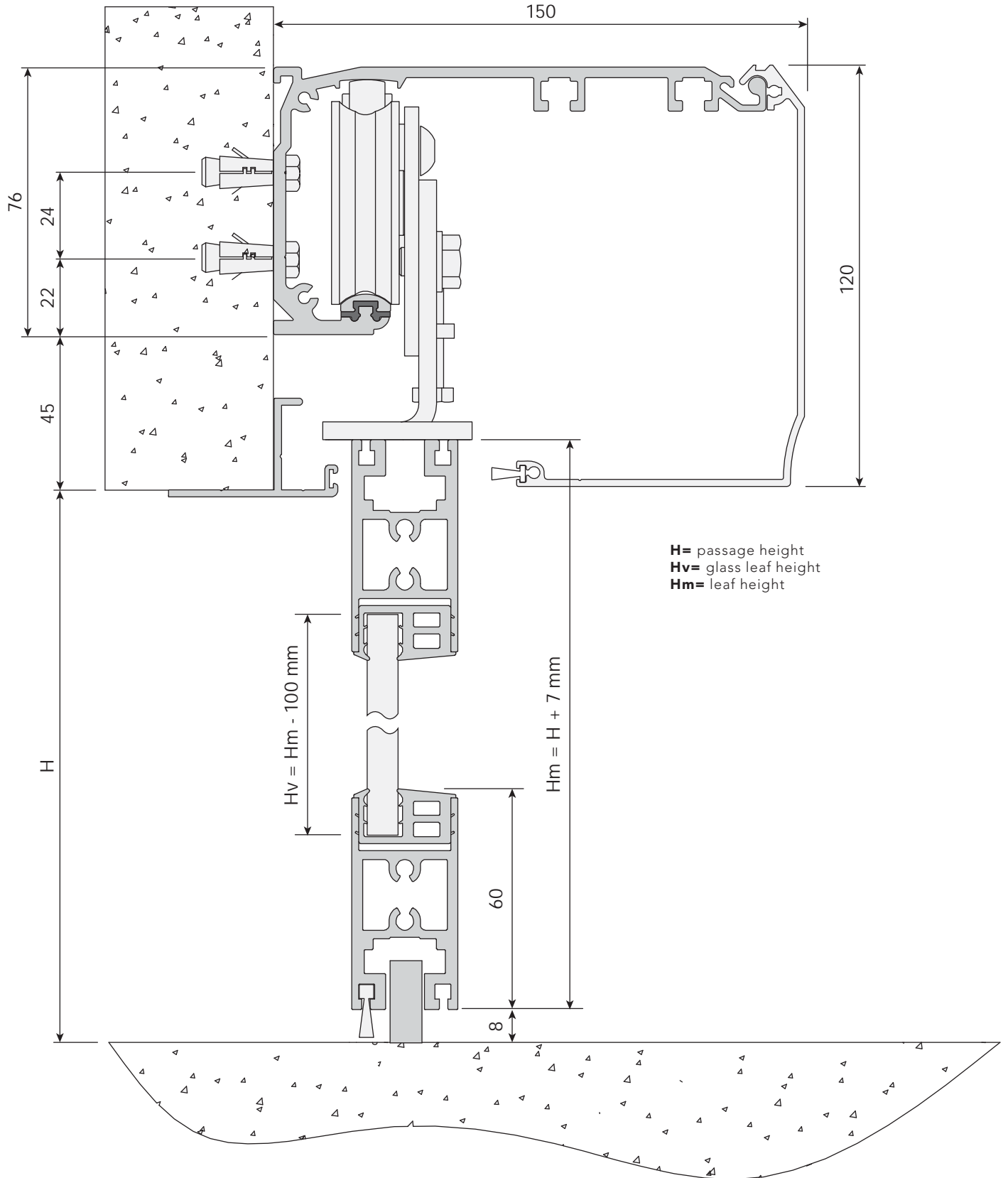



entrance with commercial profiles

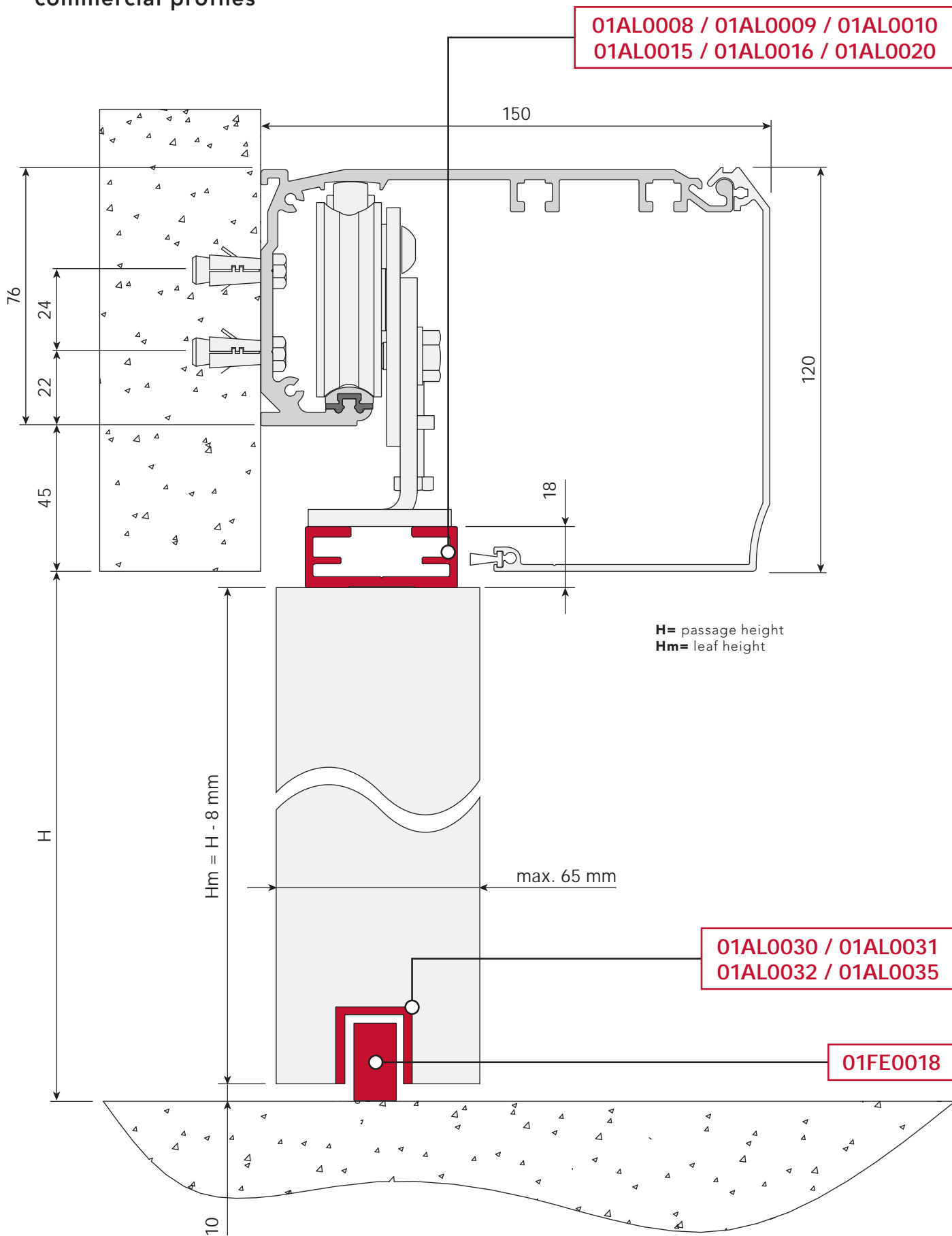



entrance with fastening set for glass leaf with pre-drilled holes

99AC0004 / 99AC0005 / 99AC0006
99AC0016 / 99AC0021 / 99AC0029

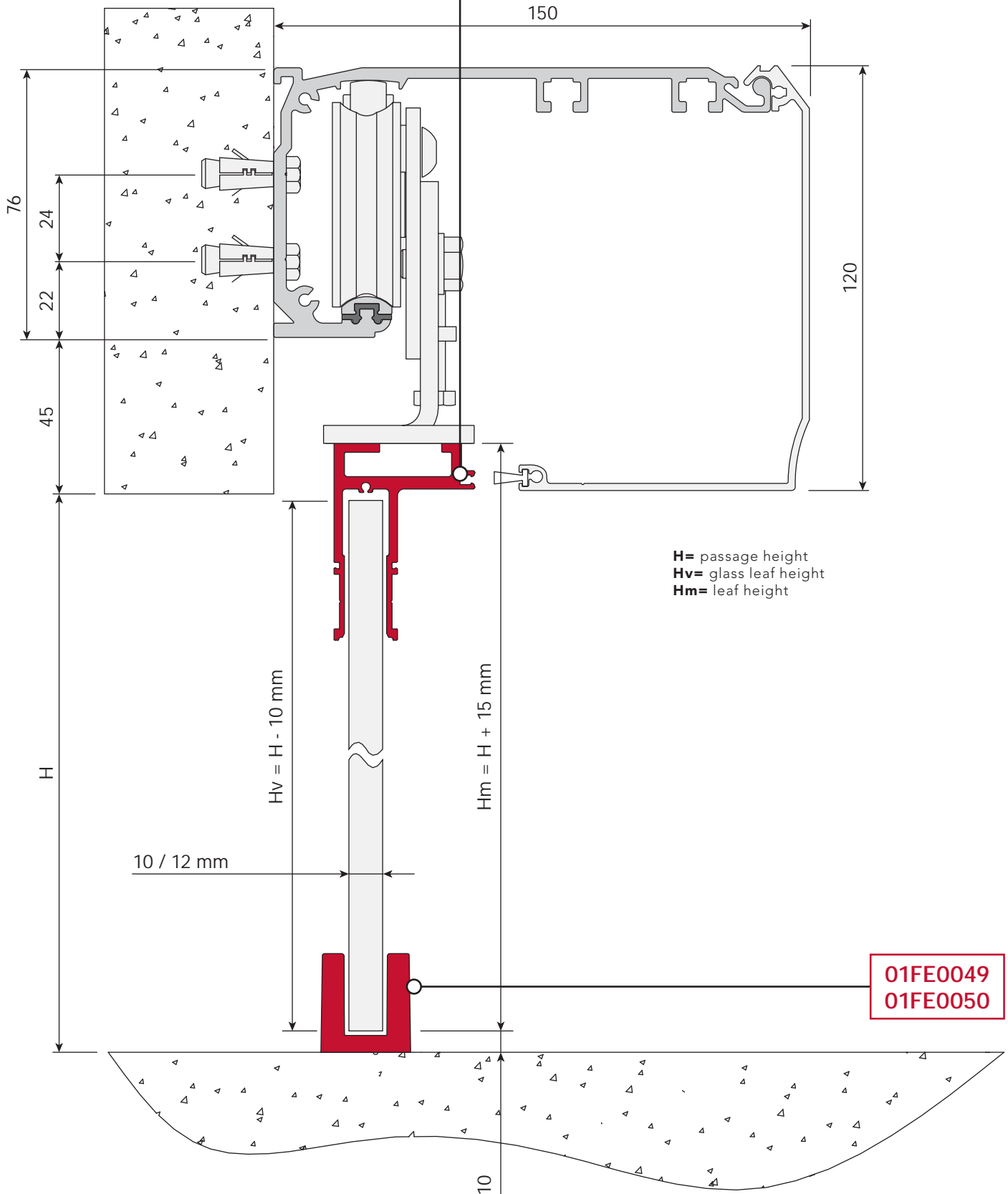

entrance with fastening set
for glass leaf to clamp

99AC0001 / 99AC0002 / 99AC0003
99AC0014 / 99AC0015 / 99AC0027

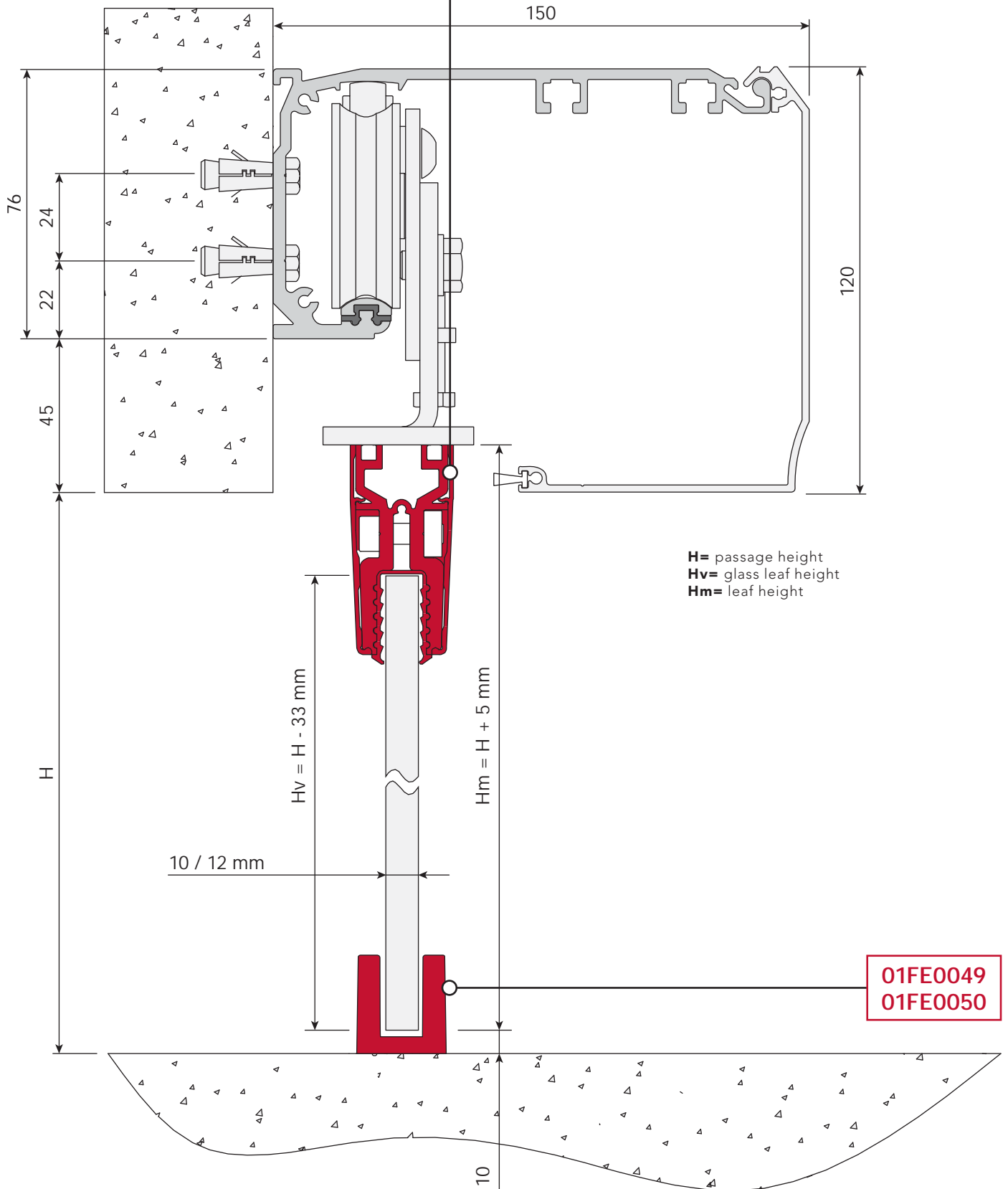

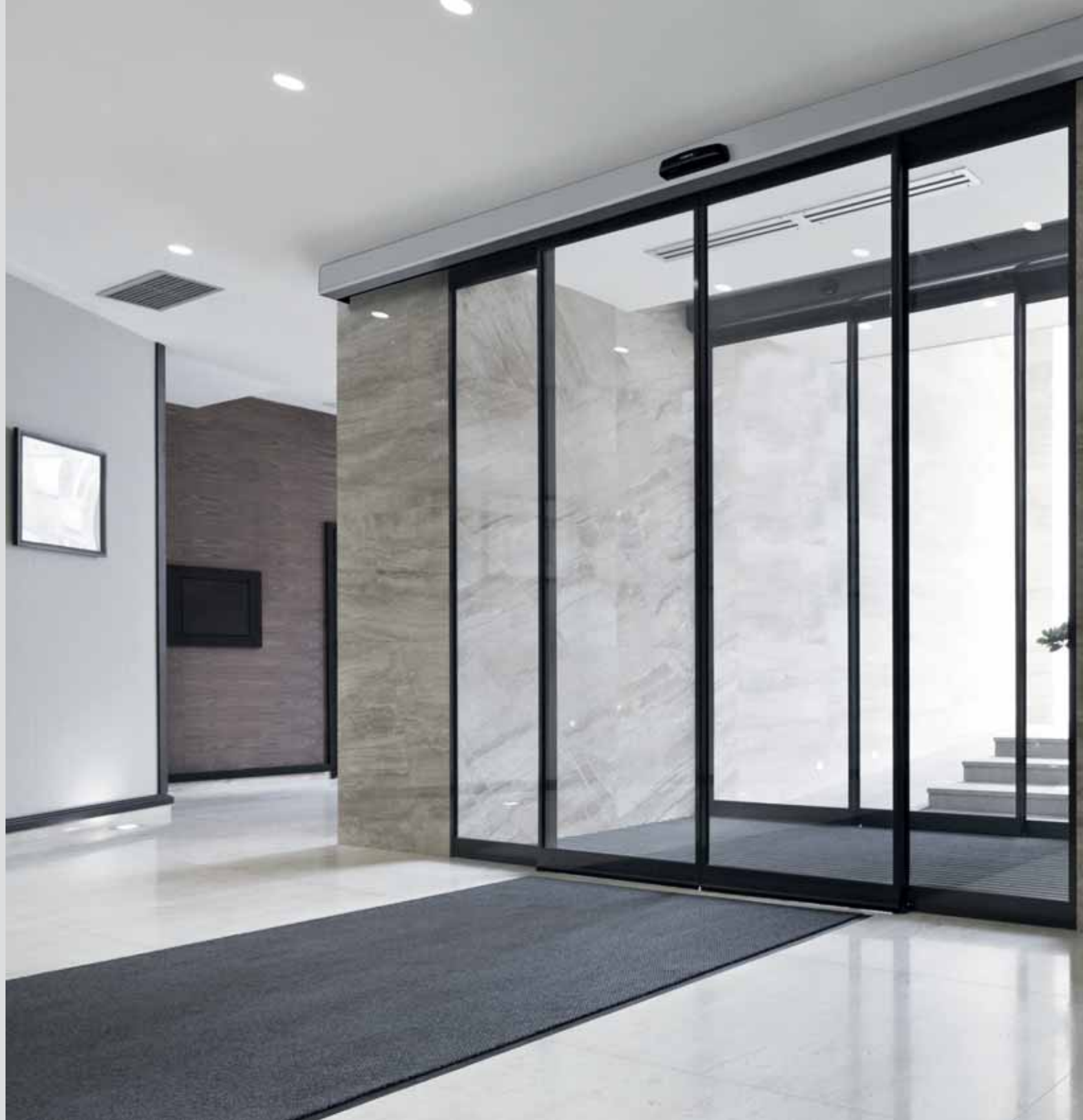

LUCE HEAVY



standard sliding doors

The Luce Heavy sliding doors are ideal for automated pedestrian access points in private and public locations: offices, shops and commercial businesses in general. They are quick and easy to install, with continuous operation, guaranteeing top performance and reliability. Available in single-leaf (up to 200 kg) or double-leaf (up to 130+130 kg) versions.



LUCE HEAVY



download LUCE HEAVY
instructions
and certificates

www.myoneautomation.com

Operator for sliding doors with three-wheeled carriage, which ensures that the doors are very stable and easy to adjust, both in height and depth.

The operator has a control unit with LED alphanumeric display, full-range switching power supply (100-240 V 50/60 Hz) and battery charger. The presence of a USB connector makes it quick and easy to update the firmware as well as to copy parameters and operating logics to a new system instantly. Continuous operation guaranteed.

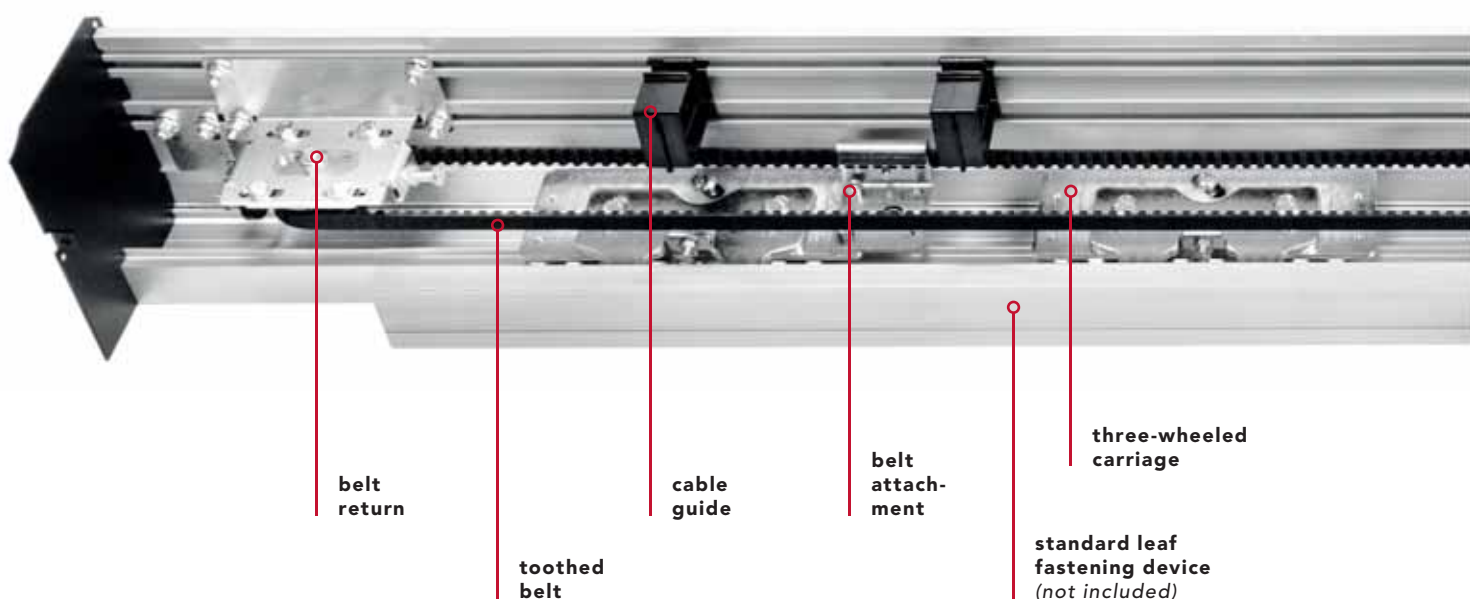

technical data

power supply	full range 100÷240 Vac 50/60 Hz
power consumption	70 W
power consumption in stand-by	3 W
accessories power supply	24 Vdc = / 1 A max
maximum speed 1 door	0.8 m/s
maximum speed 2 doors	1.6 m/s
maximum load 1 door	200 kg
maximum load 2 doors	130 + 130 kg
type and frequency of use	continuous operation = 100%
operating temperature	-15°C / +50°C
protection degree	IP20
data backup memory	USB flash drive



1 leaf
max. weight
200 kg



2 leaves
max. weight
130 + 130 kg



preassembled sliding doors

*The values of the passage size (A) and of the leaf are indicative and include an overlap of around 50 mm.

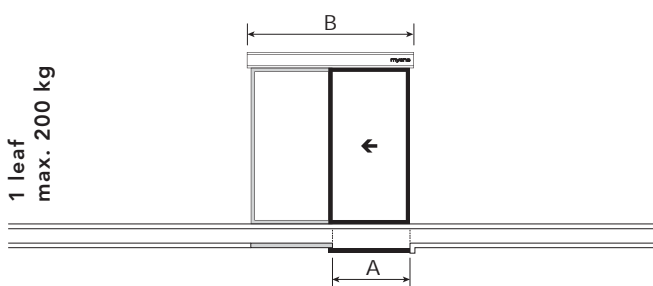

1 leaf
max. 200 kg

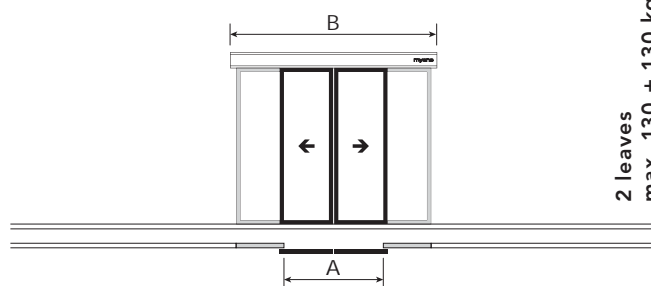

2 leaves
max. 130 + 130 kg

	A	B
LUCEH1901	900 mm	1900 mm
LUCEH2101	1000 mm	2100 mm
LUCEH2501	1200 mm	2500 mm
LUCEH2901	1400 mm	2900 mm
LUCEH3301	1600 mm	3300 mm
LUCEH3701	1800 mm	3700 mm
LUCEH4201	2000 mm	4200 mm
LUCEH5001	2450 mm	5000 mm
LUCEH6501	3100 mm	6500 mm

	A	B
LUCEH1902	900 mm	1900 mm
LUCEH2102	1000 mm	2100 mm
LUCEH2502	1200 mm	2500 mm
LUCEH2902	1400 mm	2900 mm
LUCEH3302	1600 mm	3300 mm
LUCEH3702	1800 mm	3700 mm
LUCEH4202	2000 mm	4200 mm
LUCEH5002	2450 mm	5000 mm
LUCEH6502	3100 mm	6500 mm

the preassembled operator is made up of:

control unit | gear motor with encoder | three-wheeled sliding carriages | supporting profile | anodised aluminium cover | belt return | mechanical stop | belt | cable guide | screw kit | lateral sides



kit for doors with one sliding leaf

KLUCE01

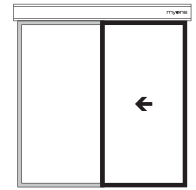

gear motor with encoder and electronic control unit



belt return



cable guides



three-wheeled sliding carriages



mechanical limit switch

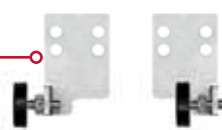

belt connection



lateral sides



screw kit



LUCE HEAVY - accessories to complete the kit



01AL0027 - 4,2 m
01AL0028 - 6,5 m

Raw aluminium supporting profile with anodised sliding guide and gasket.
- 2,95 kg/m



01AL0006 - 4,2 m
01AL0023 - 6,5 m

Anodised aluminium cover.
- 1.52 kg/m



32CG0001 - 50 m
32CG0004 - 1 m

Belt.



01IM0007

Packaging kit with headers.



kit for doors
with two sliding leaves

KLUCE02

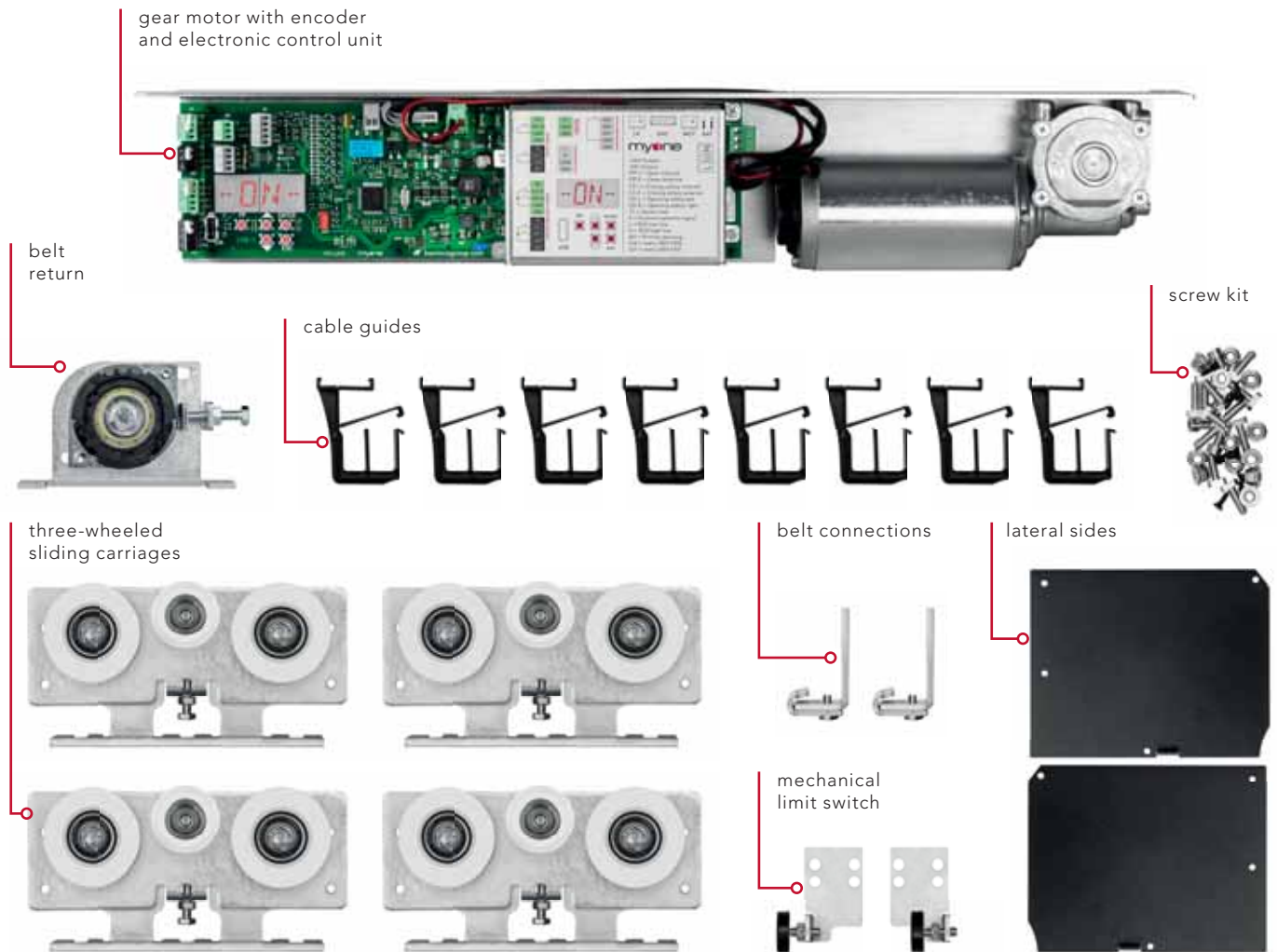
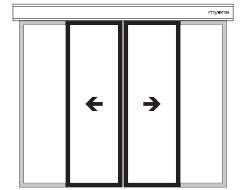

LUCE HEAVY - accessories to complete the kit



01AL0027 - 4,2 m
01AL0028 - 6,5 m

Raw aluminium supporting profile with anodised sliding guide and gasket.
- 2,95 kg/m



01AL0006 - 4,2 m
01AL0023 - 6,5 m

Anodised aluminium cover.
- 1.52 kg/m



32CG0001 - 50 m
32CG0004 - 1 m

Belt.



011M0007

Packaging kit with headers.



discover the Myone frame range

pg. 106

framed door accessories - commercial frame



01AL0030 - 1000 mm
01AL0031 - 1500 mm
01AL0032 - 2000 mm
01AL0035 - 3000 mm

Aluminium floor guide for one leaf.



01FE0018

Floor guide slider.



01AL0008 - 1000 mm **01AL0015** - 3000 mm
01AL0009 - 1500 mm **01AL0016** - 5670 mm
01AL0010 - 2000 mm **01AL0020** - 6500 mm

Standard leaf fastening device complete with fixing brackets for the carriage.



90RM0053

Pair of leaf fixing brackets (1 leaf).

glass door accessories - fastening set for glass leaves with pre-drilled holes



99AC0004 - 1000 mm **99AC0016** - 3000 mm
99AC0005 - 1500 mm **99AC0021** - 5670 mm
99AC0006 - 2000 mm **99AC0029** - 6500 mm

Fastening set for glass leaf (10-12 mm) with pre-drilled holes.



01FE0049

Glass door slider.
- 6 piece pack



01FE0050

Glass door stainless steel slider.



01GM0001

Adhesive gasket for glass leaf.
- 6 m pack

glass door accessories - fastening clamp set for glass leaves



99AC0001 - 1000 mm **99AC0014** - 3000 mm
99AC0002 - 1500 mm **99AC0015** - 5670 mm
99AC0003 - 2000 mm **99AC0027** - 6500 mm

Fastening clamp set for glass leaf (10-12 mm thickness).



01FE0049

Glass door slider.
- 6 piece pack



01FE0050

Glass door stainless steel slider.



01GM0001

Adhesive gasket for glass leaf.
- 6 m pack



accessories



99BA0003

Emergency battery kit with wiring and bracket.



99EB0001

Electromechanical lock kit with release cord.



99EB0003

Emergency electromechanical lock kit with release cord.



99EB0006

Electromechanical lock kit for return with release cord.



99AE0001

Opening device with elastic to be used with 99EB0003 electromechanical lock.



01FE0059

Safe for external release.

other accessories available on page 100

operator cross-section technical drawing

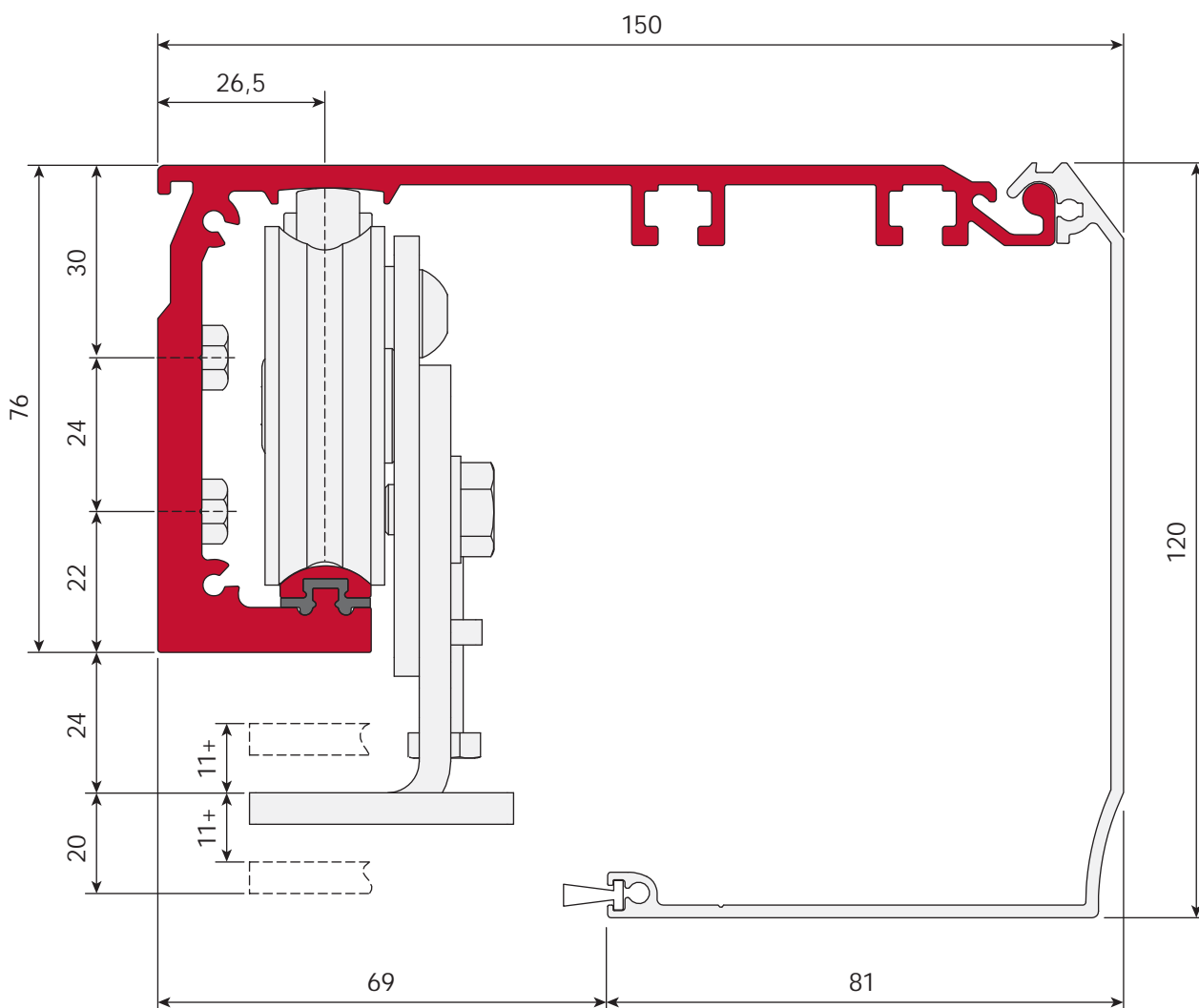



entrance with M30 myone frame

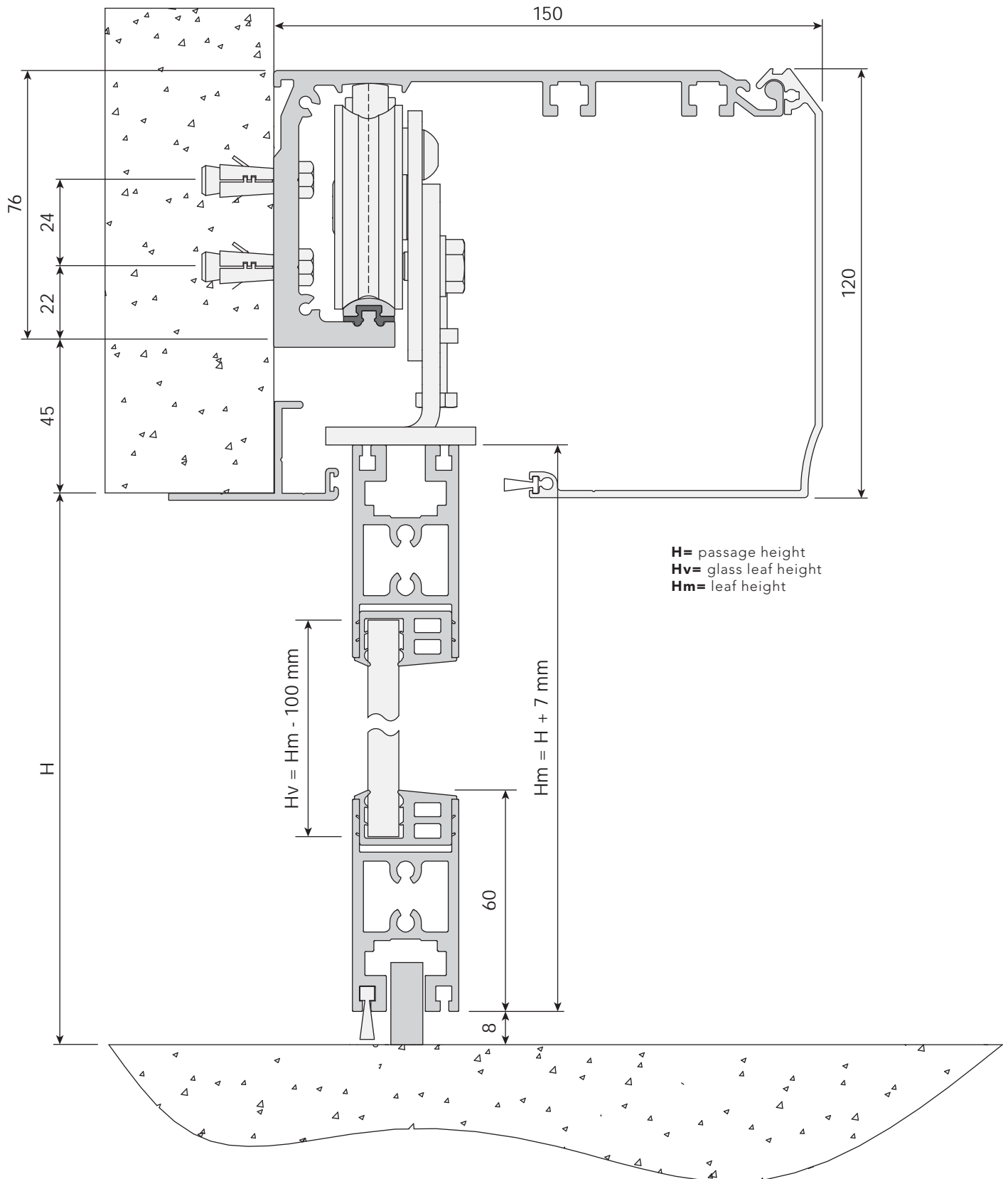



entrance with commercial profiles

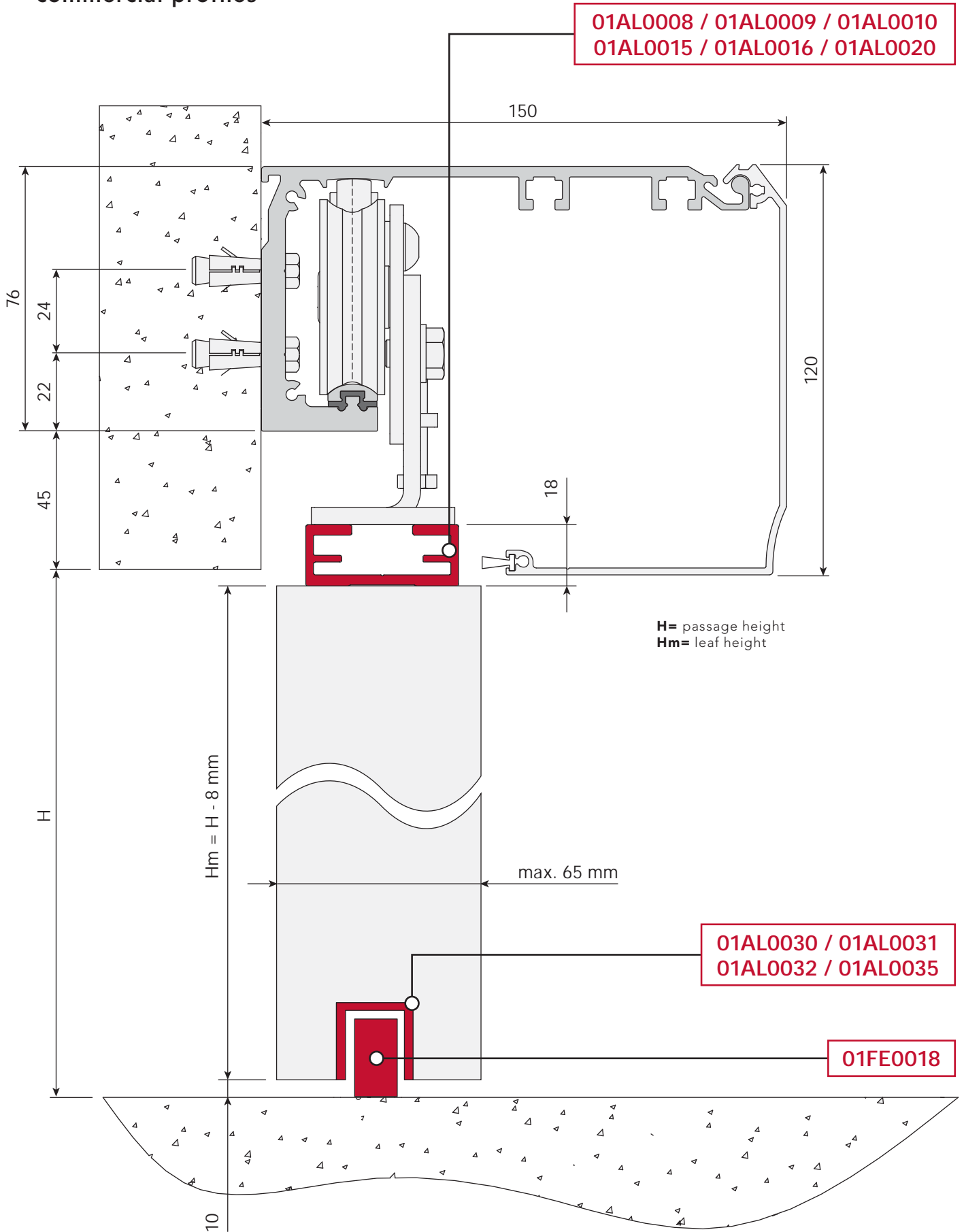



entrance with fastening set for glass leaf with pre-drilled holes

99AC0004 / 99AC0005 / 99AC0006
99AC0016 / 99AC0021 / 99AC0029

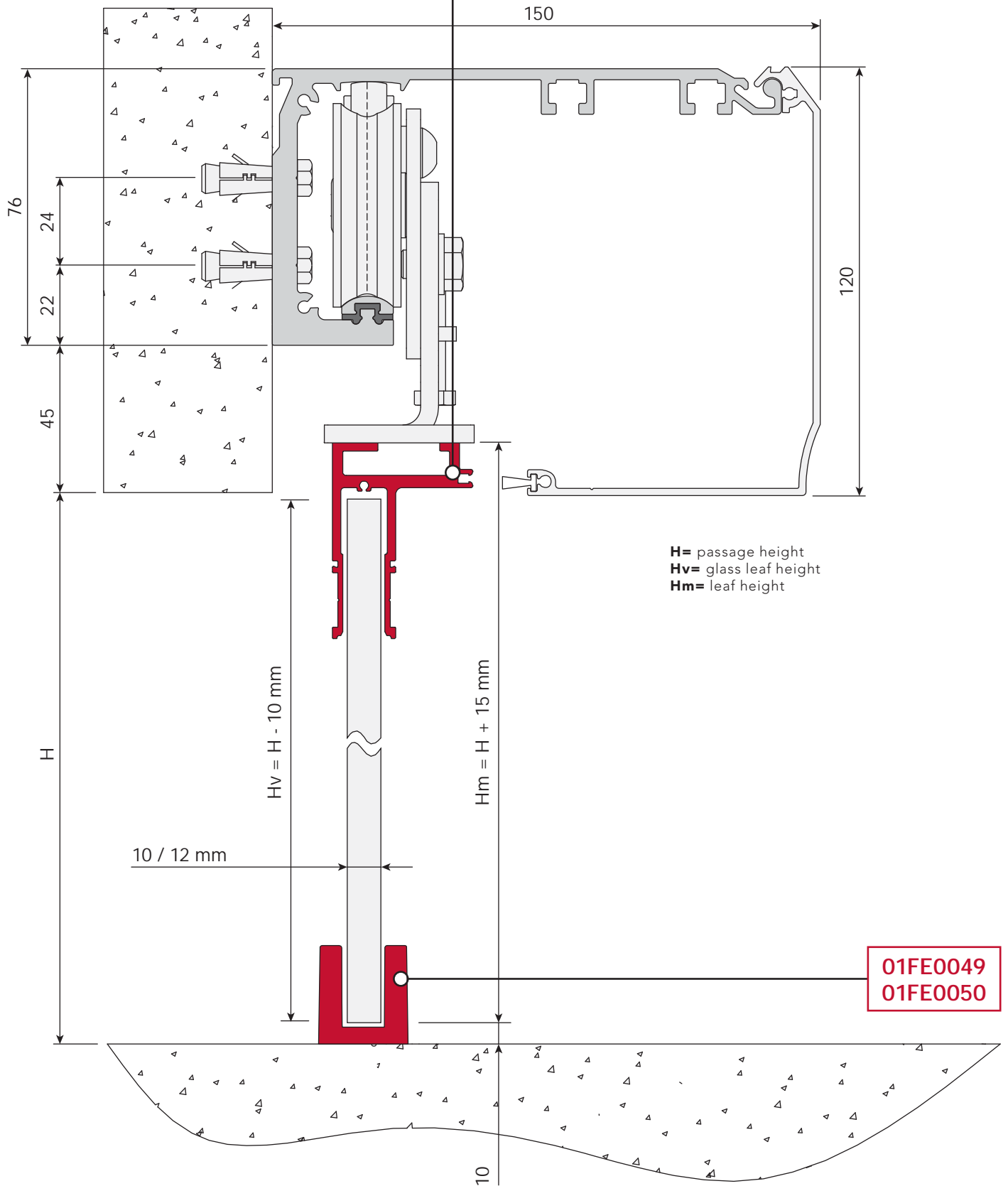



entrance with fastening set for glass leaf to clamp

99AC0001 / 99AC0002 / 99AC0003
99AC0014 / 99AC0015 / 99AC0027

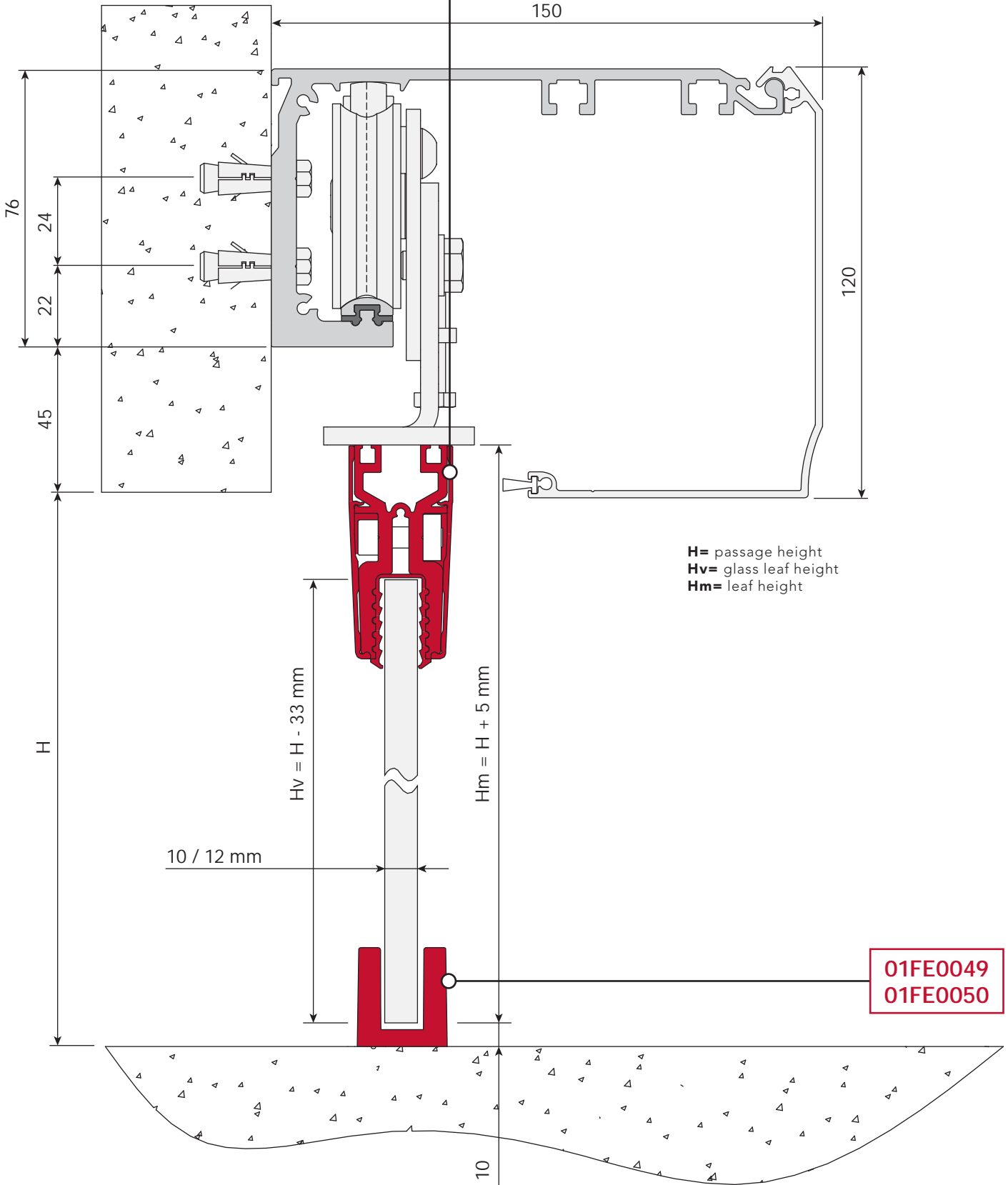



LUCE T



telescopic sliding doors

The Luce T telescopic sliding door operators are perfect for automating locations where there is limited space to the side of the passage. Available in two-leaves (100+100 kg) or four-leaves (70+70+70+70 kg) versions.



LUCE T



download LUCE T
instructions
and certificates

www.myoneautomation.com

Operator for sliding doors with three-wheeled carriages, which ensures that the doors are very stable and easy to adjust, both in height and depth. The operator has a control unit with LED alphanumeric display, full-range switching power supply (100-240 V 50/60 Hz) and battery charger. The presence of a USB connector makes it quick and easy to update the firmware as well as to copy parameters and operating logics to a new system instantly. Continuous operation guaranteed.

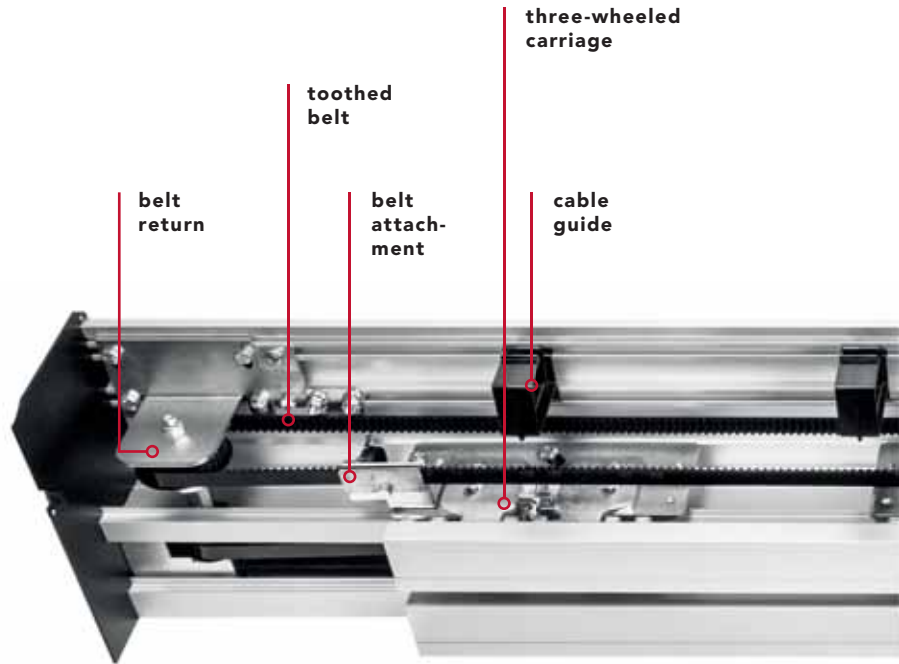

2 leaves
max. weight
100 + 100 kg



4 leaves
max. weight
70 + 70 + 70 + 70 kg

technical data

power supply	full range 100÷240 Vac 50/60 Hz
power consumption	70 W
power consumption in stand-by	3 W
accessories power supply	24 Vdc = / 1 A max
maximum speed 2 doors	0.8 m/s
maximum speed 4 doors	1.6 m/s
maximum load 2 doors	100 + 100 kg
maximum load 4 doors	70 + 70 + 70 + 70 kg
type and frequency of use	continuous operation = 100%
operating temperature	-15°C / +50°C
protection degree	IP20
data backup memory	USB flash drive

preassembled telescopic doors

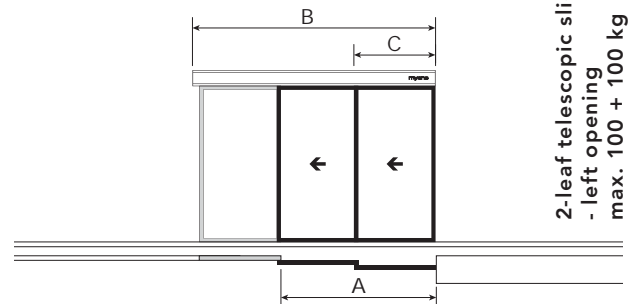

2-leaf telescopic sliding door
- left opening
max. 100 + 100 kg

	A	B	C	
LUCET1902L	1180 mm	1900 mm	2x	666 mm
LUCET2102L	1320 mm	2100 mm	2x	730 mm
LUCET2502L	1590 mm	2500 mm	2x	860 mm
LUCET2902L	1850 mm	2900 mm	2x	995 mm
LUCET3302L	2120 mm	3300 mm	2x	1130 mm
LUCET3702L	2385 mm	3700 mm	2x	1260 mm
LUCET4202L	2710 mm	4200 mm	2x	1430 mm
LUCET5002L	3250 mm	5000 mm	2x	1695 mm
LUCET6502L	4250 mm	6500 mm	2x	2195 mm

*The values of the passage size (A) and of the leaf (C) are indicative and include an overlap of around 50 mm.

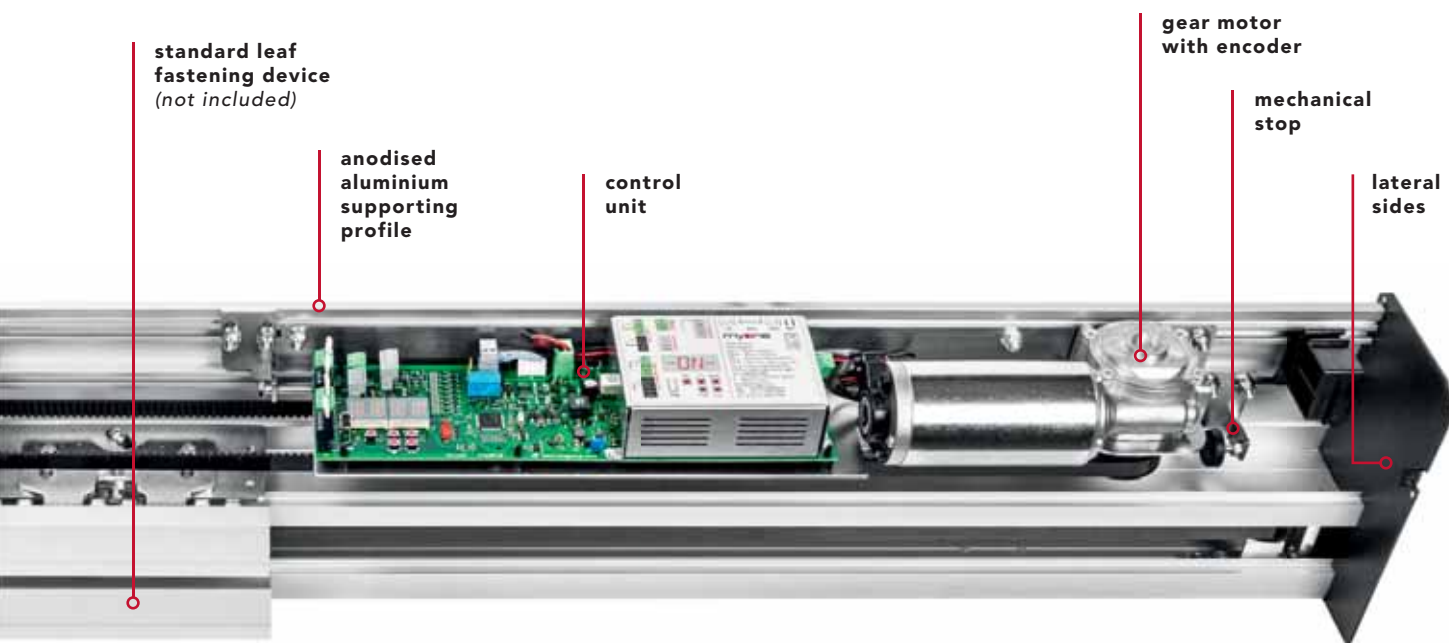

2-leaf telescopic sliding door
- right opening
max. 100 + 100 kg

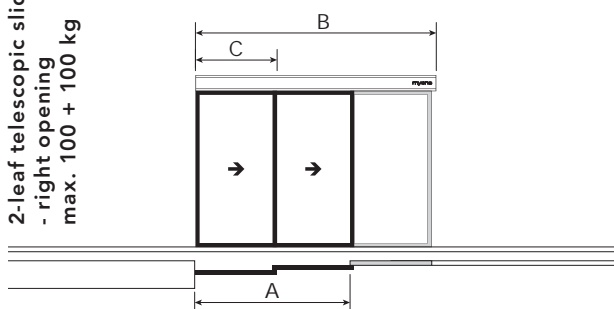

	A	B	C
LUCET1902R	1180 mm	1900 mm	2x 666 mm
LUCET2102R	1320 mm	2100 mm	2x 730 mm
LUCET2502R	1590 mm	2500 mm	2x 860 mm
LUCET2902R	1850 mm	2900 mm	2x 995 mm
LUCET3302R	2120 mm	3300 mm	2x 1130 mm
LUCET3702R	2385 mm	3700 mm	2x 1260 mm
LUCET4202R	2710 mm	4200 mm	2x 1430 mm
LUCET5002R	3250 mm	5000 mm	2x 1695 mm
LUCET6502R	4250 mm	6500 mm	2x 2195 mm

4-leaf telescopic sliding door
max. 70 + 70 + 70 + 70 kg

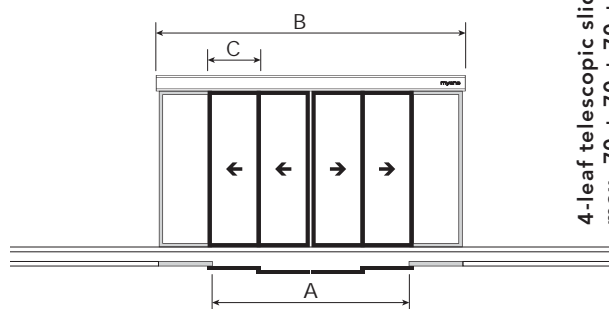

	A	B	C
LUCET2904	1860 mm	2900 mm	4x 510 mm
LUCET3304	2120 mm	3300 mm	4x 580 mm
LUCET3704	2390 mm	3700 mm	4x 648 mm
LUCET4204	2725 mm	4200 mm	4x 730 mm
LUCET5004	3260 mm	5000 mm	4x 865 mm
LUCET6504	4260 mm	6500 mm	4x 1110 mm

the preassembled operator is made up of:

control unit | gear motor with encoder | three-wheeled sliding carriages | anodised aluminium supporting profile and cover | belt return | mechanical stop | belt | cable guide | screw kit | lateral sides



discover the Myone frame range

pg. 106

framed door accessories -
commercial frame

01AL0030 - 1000 mm
01AL0031 - 1500 mm
01AL0032 - 2000 mm
01AL0035 - 3000 mm

Aluminium floor
guide for one leaf.



01FE0018

Floor guide
slider.



01FE0018T

Floor guide
slider for fast
movable door.
- right/left



01AL0008 - 1000 mm
01AL0009 - 1500 mm
01AL0010 - 2000 mm

01AL0015 - 3000 mm
01AL0016 - 5670 mm
01AL0020 - 6500 mm

Standard leaf fastening device complete
with fixing brackets for the carriage.



90RM0053

Pair of leaf fixing
brackets (1 leaf).

glass door accessories
- fastening set for glass leaves with pre-drilled holes

99AC0004 - 1000 mm
99AC0005 - 1500 mm
99AC0006 - 2000 mm

Fastening set for glass leaf
(10-12 mm) with pre-drilled holes.



01FE0050

Glass door
stainless
steel slider.



01FE0050T

Floor guide
slider for fast
movable door.
- right/left



01GM0001

Adhesive gasket
for glass leaf.
- 6 m pack

glass door accessories -
fastening clamp set for glass leaves

99AC0001 - 1000 mm
99AC0002 - 1500 mm
99AC0003 - 2000 mm
99AC0014 - 3000 mm
99AC0015 - 5670 mm
99AC0027 - 6500 mm

Fastening clamp set for glass
leaf (10-12 mm thickness).



99AC0007 - 1000 mm
99AC0008 - 1500 mm
99AC0009 - 2000 mm
99AC0028 - 3000 mm

Bottom fastening clamp
set with brushes for glass
leaf (10-12 mm thickness).



01FE0018

Floor guide
slider.



01FE0018TG

Floor guide
slider for fast
movable door.
- right/left



01GM0001

Adhesive gasket
for glass leaf.
- 6 m pack

accessories



99BA0003
Emergency battery kit with wiring and bracket.



99EB0001
Electromechanical lock kit with release cord.



99EB0003
Emergency electromechanical lock kit with release cord.



99AE0002
Opening device with elastic to be used with 99EB0003 electromechanical lock.



01FE0059
Safe for external release.

 other accessories available on page 100

operator cross-section
technical drawing

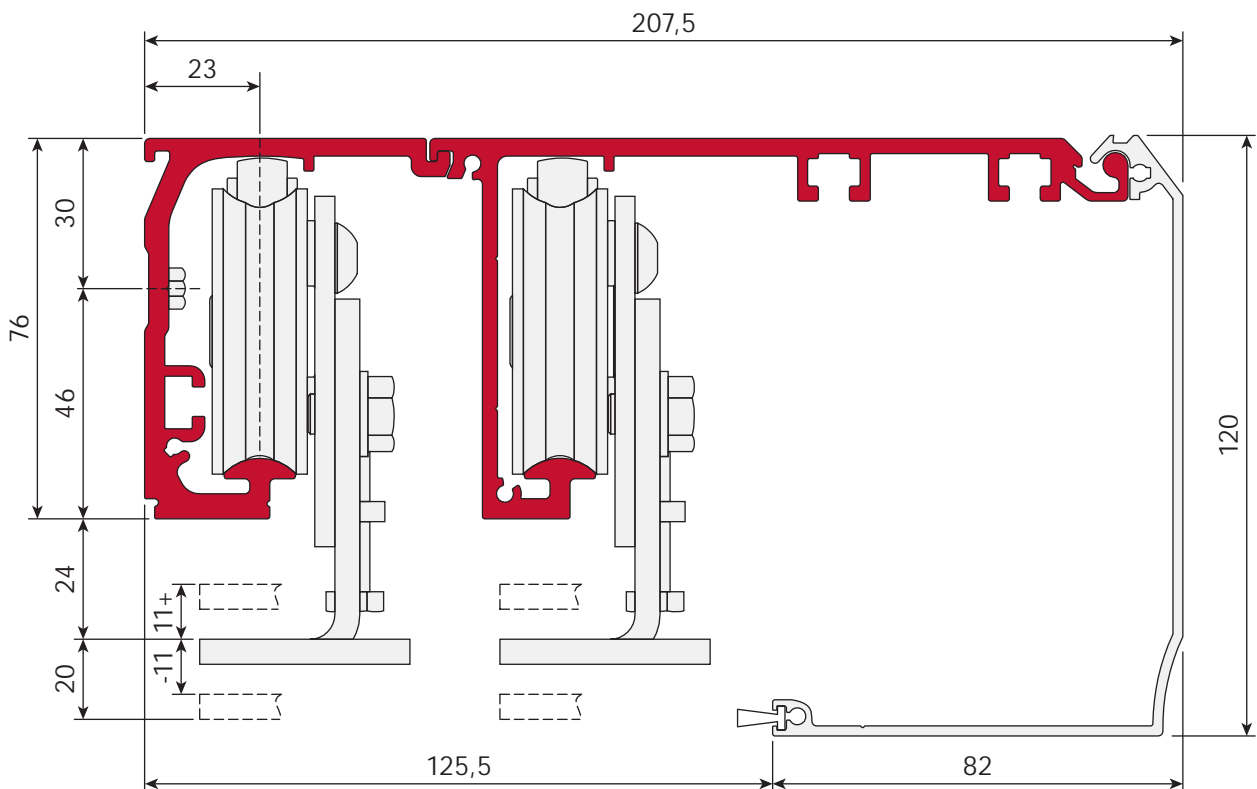



entrance with M30 myone frame

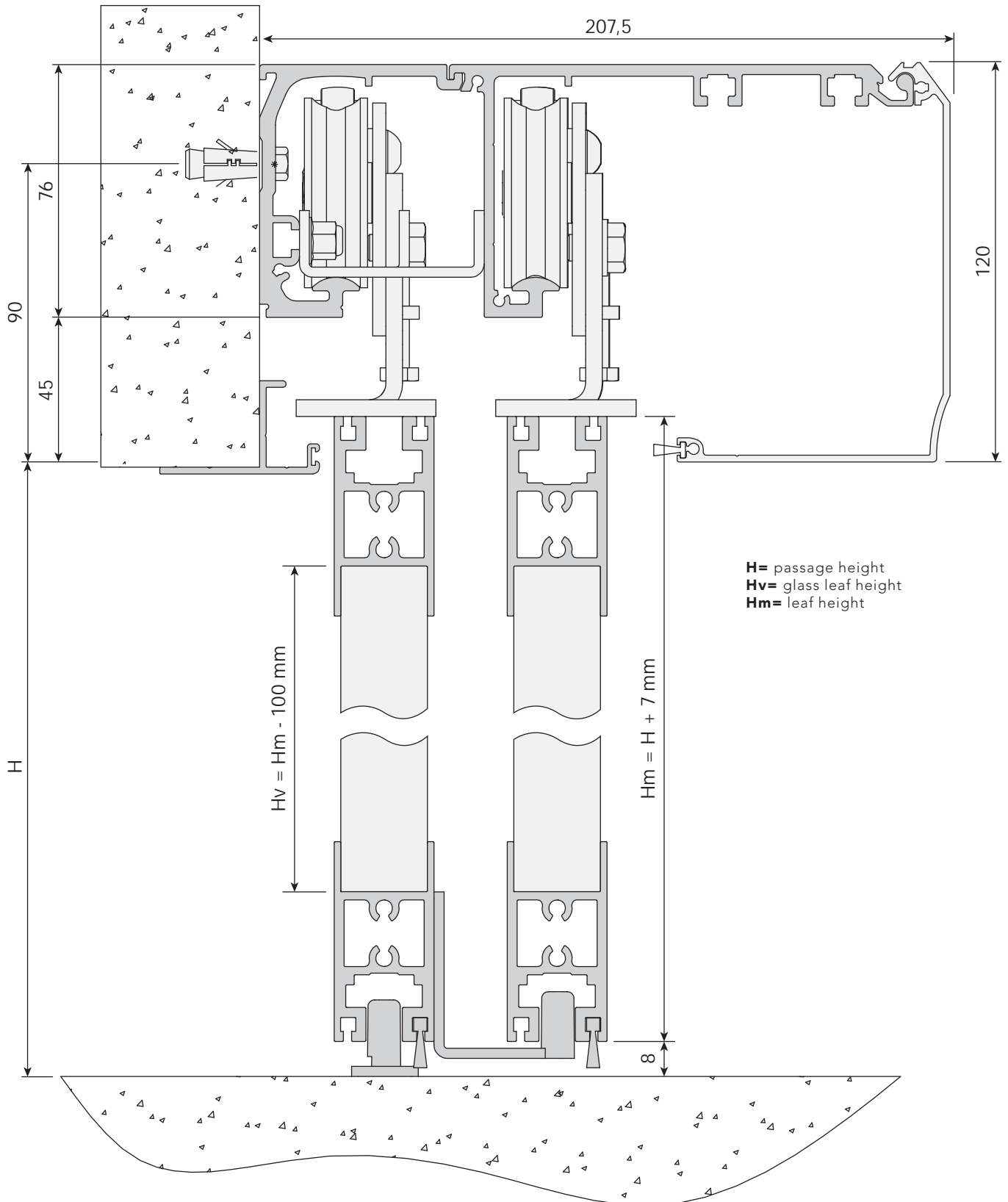



entrance with commercial profiles

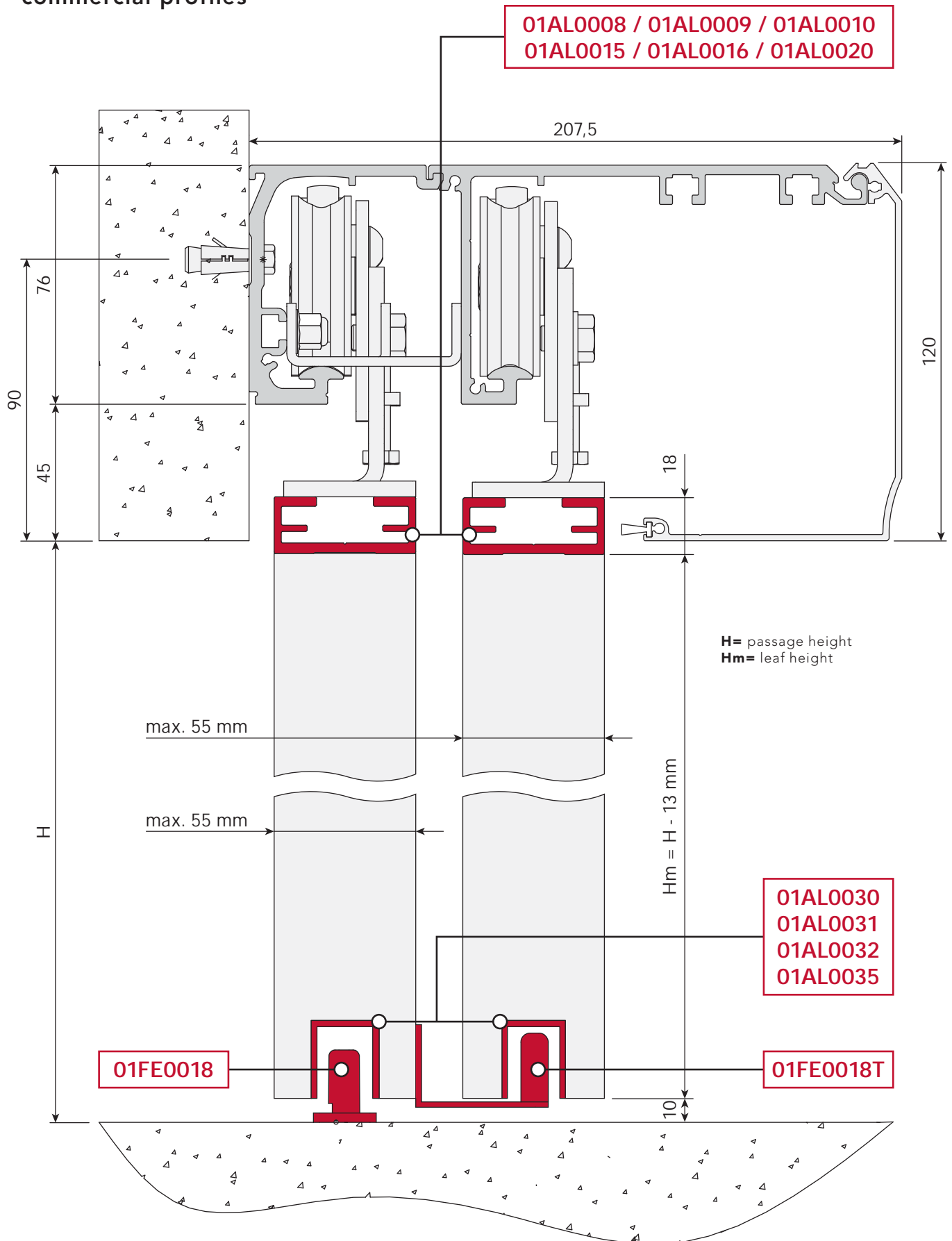



entrance with fastening set for glass leaf with pre-drilled holes

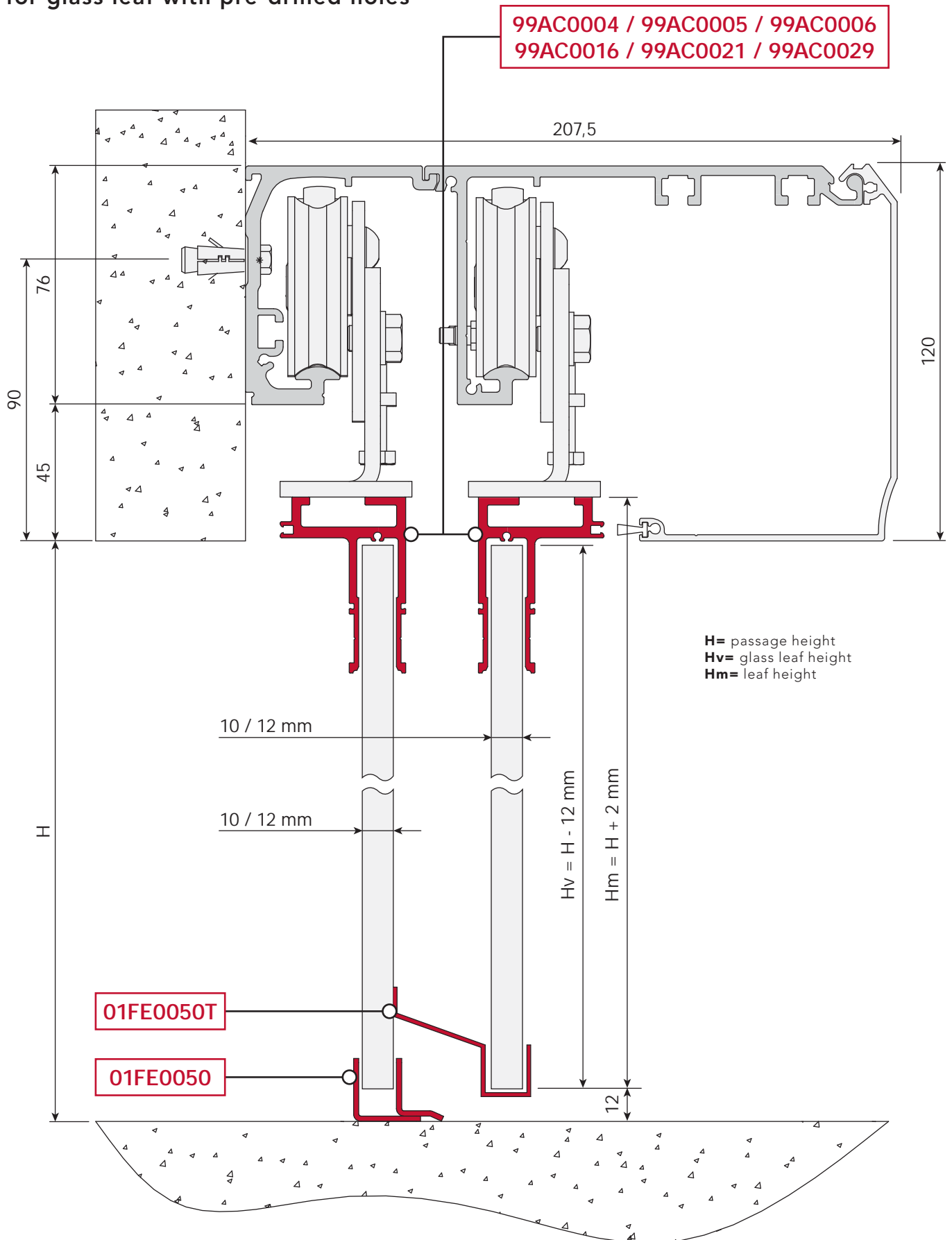



entrance with fastening set
for glass leaf to clamp

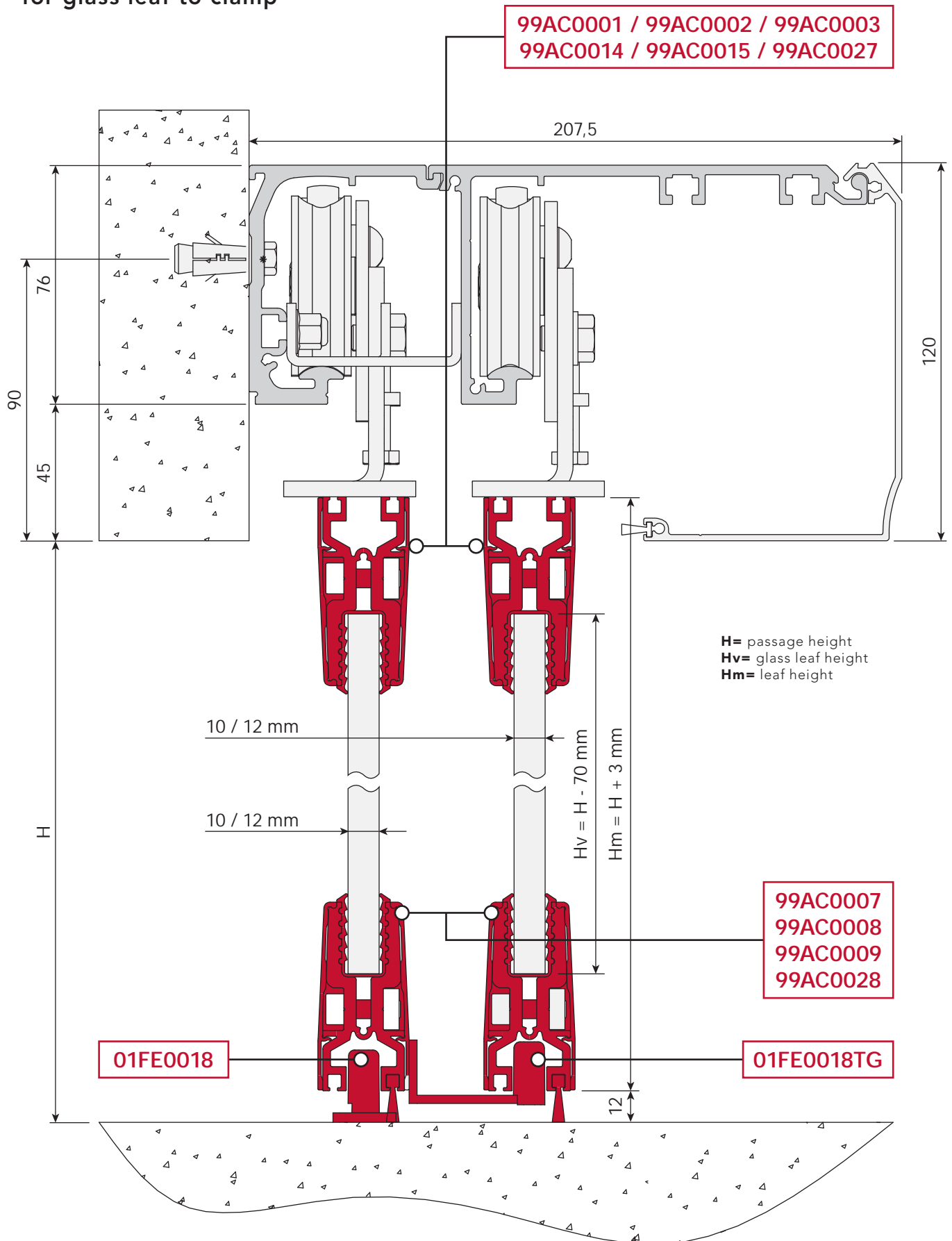



LUCE S



SLIM

**compact
sliding doors**

The Luce S automatic sliding door operators are perfect for automatic pedestrian access points in areas with specific aesthetic or architectural requirements. With its ultra-compact supporting profile and cover, only 10 cm high, the operator works perfectly in any architectural context reducing the aesthetic impact to a minimum. Also available in single-leaf (up to 110 kg) or double-leaf (up to 70+70 kg) versions.

LUCE S



download LUCE S instructions and certificates

www.myoneautomation.com

Operator for sliding doors with carriages designed to ensure that the doors are very stable and easy to adjust, both in height and depth. Reduced size system (only 10 cm high). The operator has a control unit with LED alphanumeric display, full-range switching power supply (100-240 V 50/60 Hz) and battery charger. The presence of a USB connector makes it quick and easy to update the firmware as well as to copy parameters and operating logics to a new system instantly. Continuous operation guaranteed.

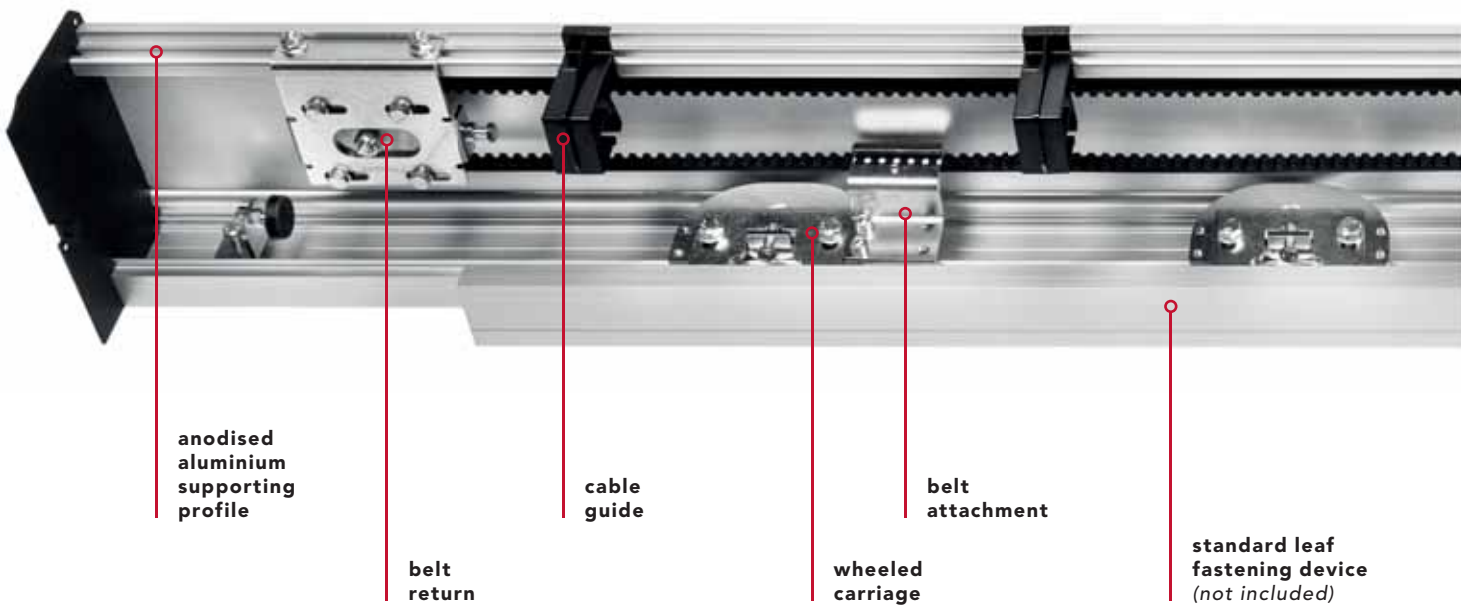

technical data

power supply	full range 100÷240 Vac 50/60 Hz
power consumption	70 W
power consumption in stand-by	3 W
accessories power supply	24 Vdc = / 1 A max
maximum speed 1 door	0.8 m/s
maximum speed 2 doors	1.6 m/s
maximum load 1 door	110 kg
maximum load 2 doors	70 + 70 kg
type and frequency of use	continuous operation = 100%
operating temperature	-15°C / +50°C
protection degree	IP20
data backup memory	USB flash drive



1 leaf
max. weight
110 kg



2 leaves
max. weight
70 + 70 kg

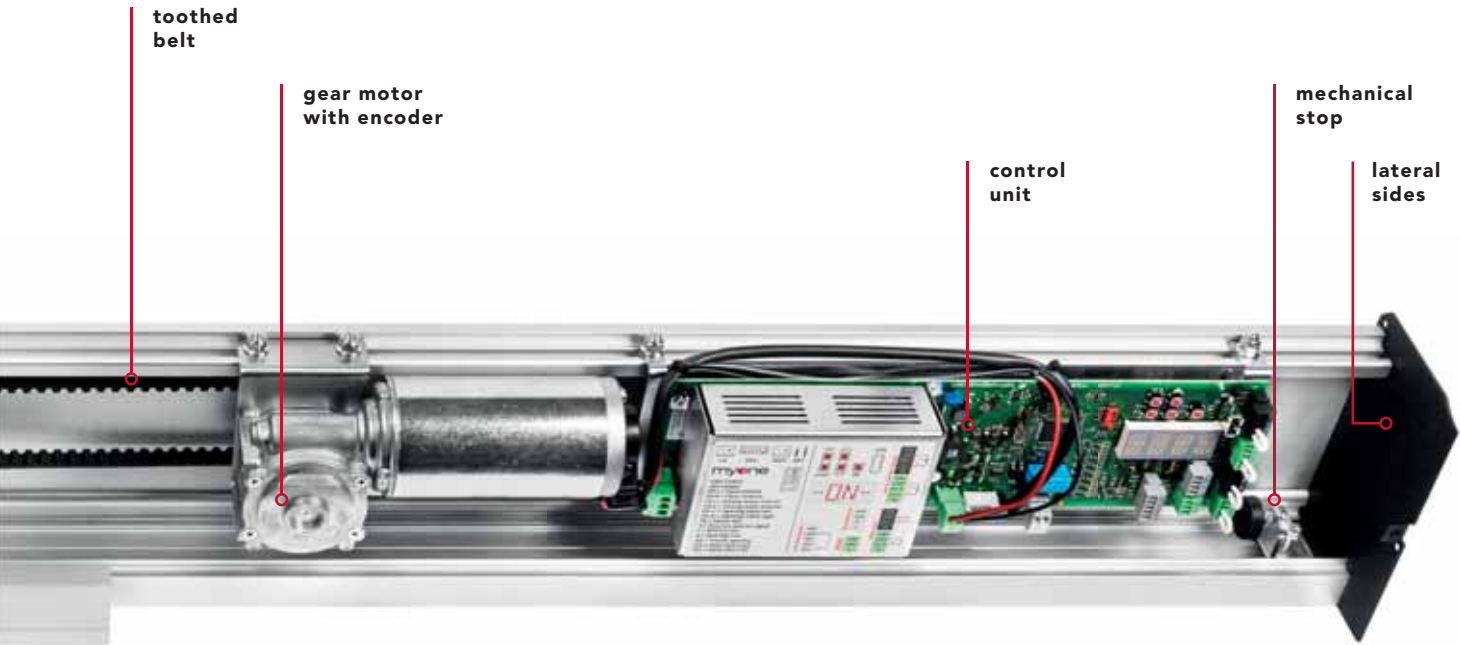

compact preassembled

*The values of the passage size (A) and of the leaf are indicative and include an overlap of around 50 mm.

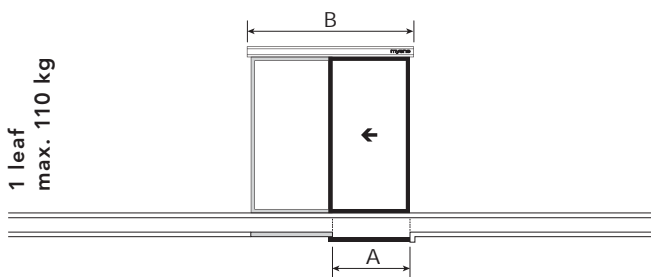

1 leaf
max. 110 kg

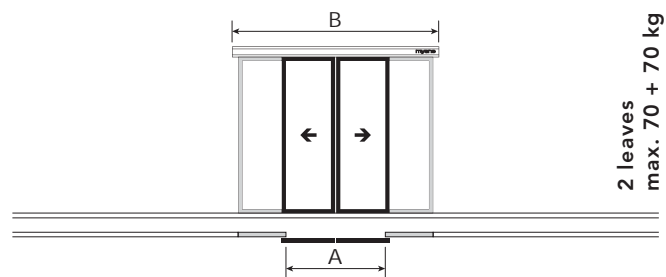

2 leaves
max. 70 + 70 kg

	A	B
LUCES1901S	900 mm	1900 mm
LUCES2101S	1000 mm	2100 mm
LUCES2501S	1200 mm	2500 mm
LUCES2901S	1400 mm	2900 mm
LUCES3301S	1600 mm	3300 mm
LUCES3701S	1800 mm	3700 mm
LUCES4201S	2000 mm	4200 mm
LUCES5001S	2450 mm	5000 mm
LUCES6501S	3100 mm	6500 mm

	A	B
LUCES1902S	900 mm	1900 mm
LUCES2102S	1000 mm	2100 mm
LUCES2502S	1200 mm	2500 mm
LUCES2902S	1400 mm	2900 mm
LUCES3302S	1600 mm	3300 mm
LUCES3702S	1800 mm	3700 mm
LUCES4202S	2000 mm	4200 mm
LUCES5002S	2450 mm	5000 mm
LUCES6502S	3100 mm	6500 mm

the preassembled operator is made up of:

control unit | gear motor with encoder | wheeled sliding carriages | anodised aluminium supporting profile and cover | belt return | mechanical stop | belt | cable guide | screw kit | lateral sides

kit for compact doors with one sliding leaf

KLUCE01S

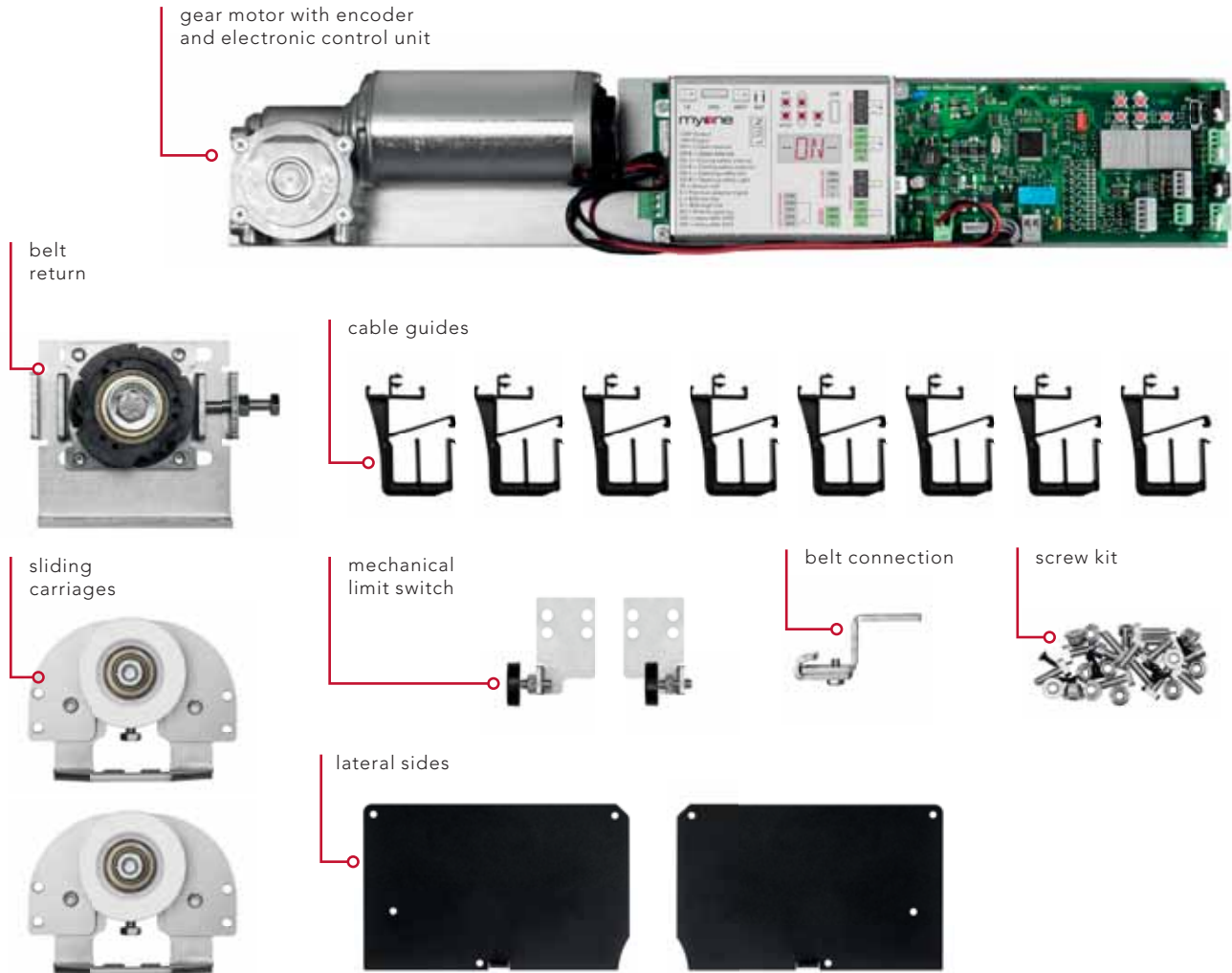
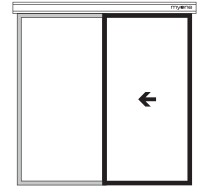

LUCE S - accessories to complete the kit



01AL0005

Anodised aluminium supporting profile.
- 2.75 kg/m



01AL0002S

Anodised aluminium cover.
- 1.25 kg/m



32CG0004

Belt.
- 1 m



32CG0001

Belt.
- 50 m



01IM0007

Packaging kit with headers.

kit for compact doors
with two sliding leaves

KLUCE02S

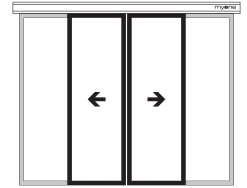

gear motor with encoder
and electronic control unit



belt
return



cable guides



sliding
carriages



mechanical
limit switch



belt connections

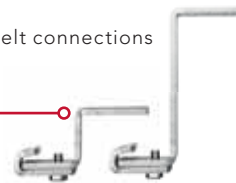

screw kit



lateral sides



LUCE S - accessories to complete the kit



01AL0005

Anodised aluminium supporting profile.
- 2.75 kg/m



01AL0002S

Anodised aluminium cover.
- 1.25 kg/m



32CG0004

Belt.
- 1 m



32CG0001

Belt.
- 50 m



01IM0007

Packaging kit with headers.

discover the Myone frame range

 pg. 106

framed door accessories - commercial frame



01AL0030 - 1000 mm
01AL0031 - 1500 mm
01AL0032 - 2000 mm
01AL0035 - 3000 mm

Aluminium floor
guide for one leaf.



01FE0018

Floor guide
slider.



01AL0008 - 1000 mm
01AL0009 - 1500 mm
01AL0010 - 2000 mm
01AL0015 - 3000 mm
01AL0016 - 5670 mm
01AL0020 - 6500 mm

Standard leaf fastening device complete
with fixing brackets for the carriage.



90RM0053

Pair of leaf fixing
brackets (1 leaf).

glass door accessories - fastening set for glass leaves with pre-drilled holes



99AC0004 - 1000 mm
99AC0005 - 1500 mm
99AC0006 - 2000 mm
99AC0016 - 3000 mm
99AC0021 - 5670 mm
99AC0029 - 6500 mm

Fastening set for glass leaf
(10-12 mm) with pre-drilled holes.



01FE0049

Glass door
slider.
- 6 piece pack



01FE0050

Glass door
stainless
steel slider.



01GM0001

Adhesive gasket
for glass leaf.
- 6 m pack

glass door accessories - fastening clamp set for glass leaves



99AC0001 - 1000 mm
99AC0002 - 1500 mm
99AC0003 - 2000 mm
99AC0014 - 3000 mm
99AC0015 - 5670 mm
99AC0027 - 6500 mm

Fastening clamp set for glass
leaf (10-12 mm thickness).



01FE0049

Glass door
slider.
- 6 piece pack



01FE0050

Glass door
stainless
steel slider.



01GM0001

Adhesive gasket
for glass leaf.
- 6 m pack

accessories



99BA0005

Emergency battery kit with wiring and bracket.



99EB0007

Electromechanical lock kit for return with release cord.



01FE0059

Safe for external release.

 other accessories available on page 100

operator cross-section
technical drawing

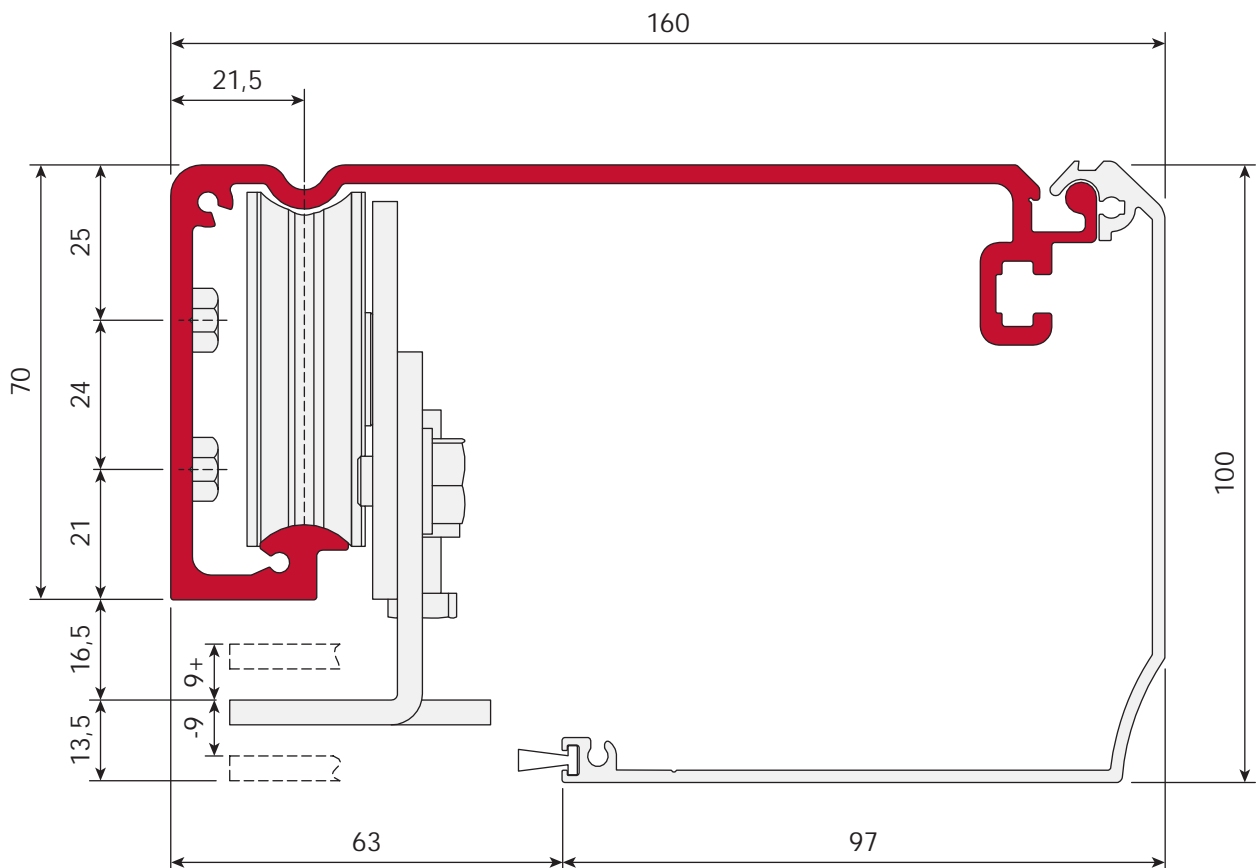

entrance with M30
myone frame

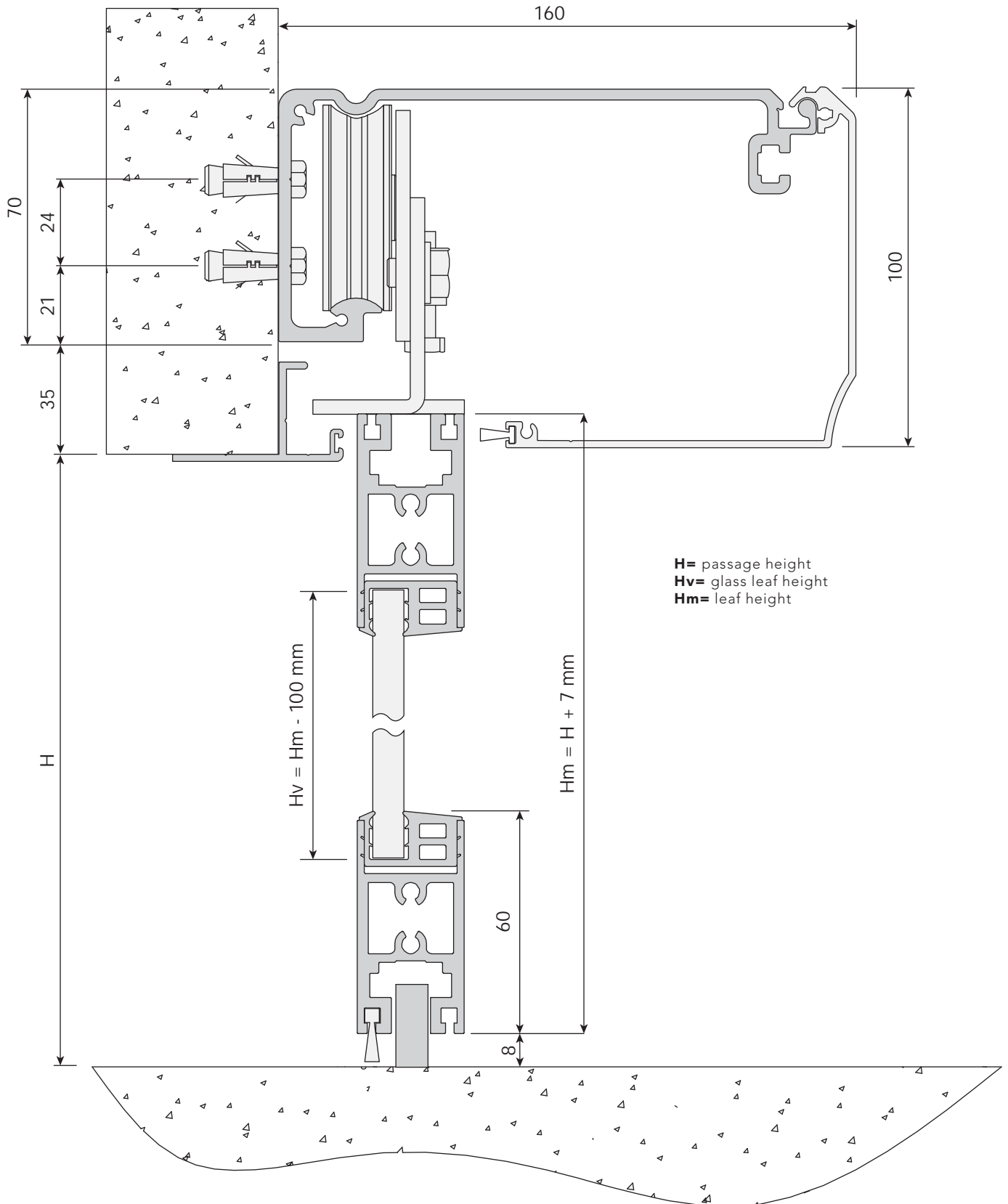

entrance with commercial profiles

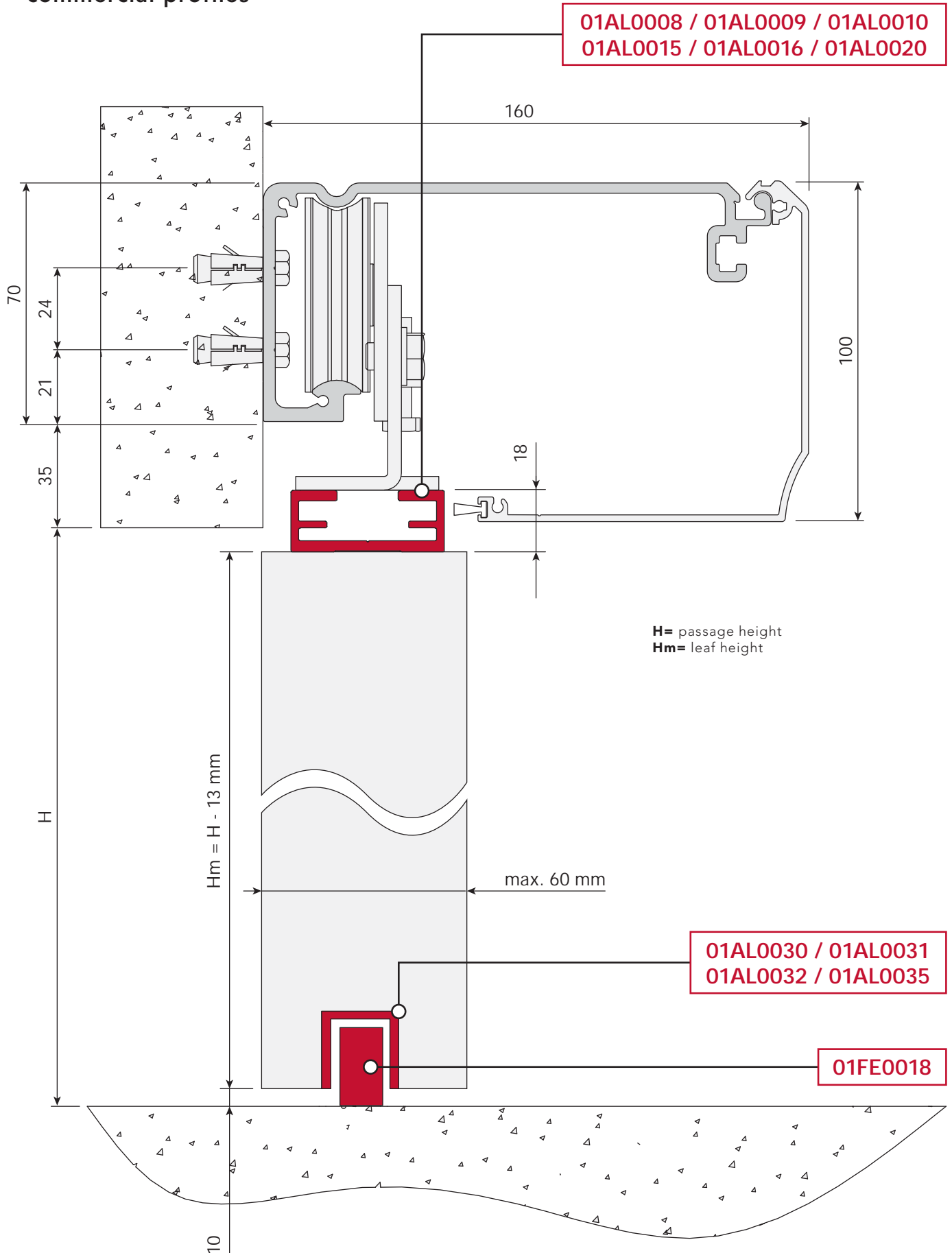

entrance with fastening set
for glass leaf with pre-drilled holes

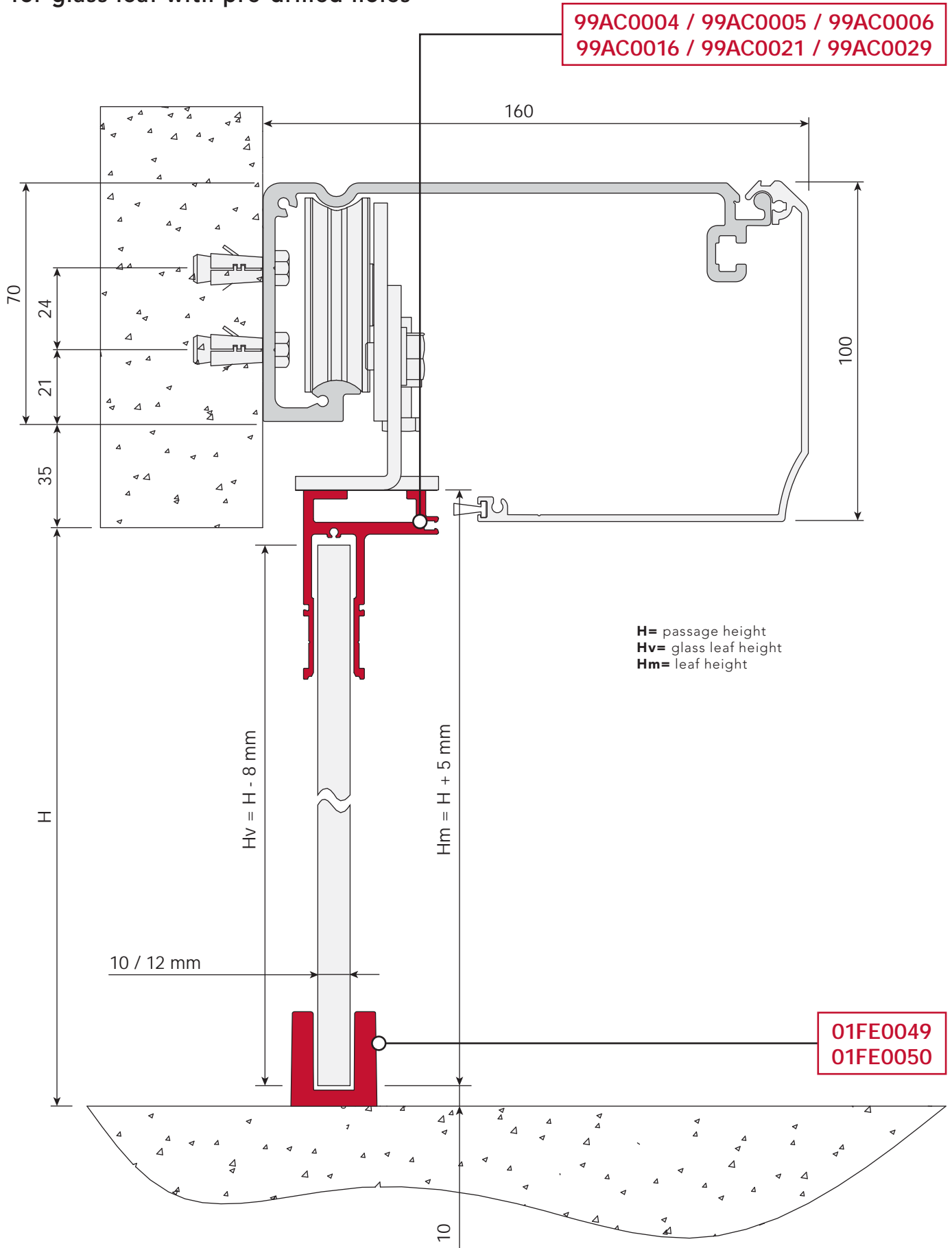

entrance with fastening set
for glass leaf to clamp

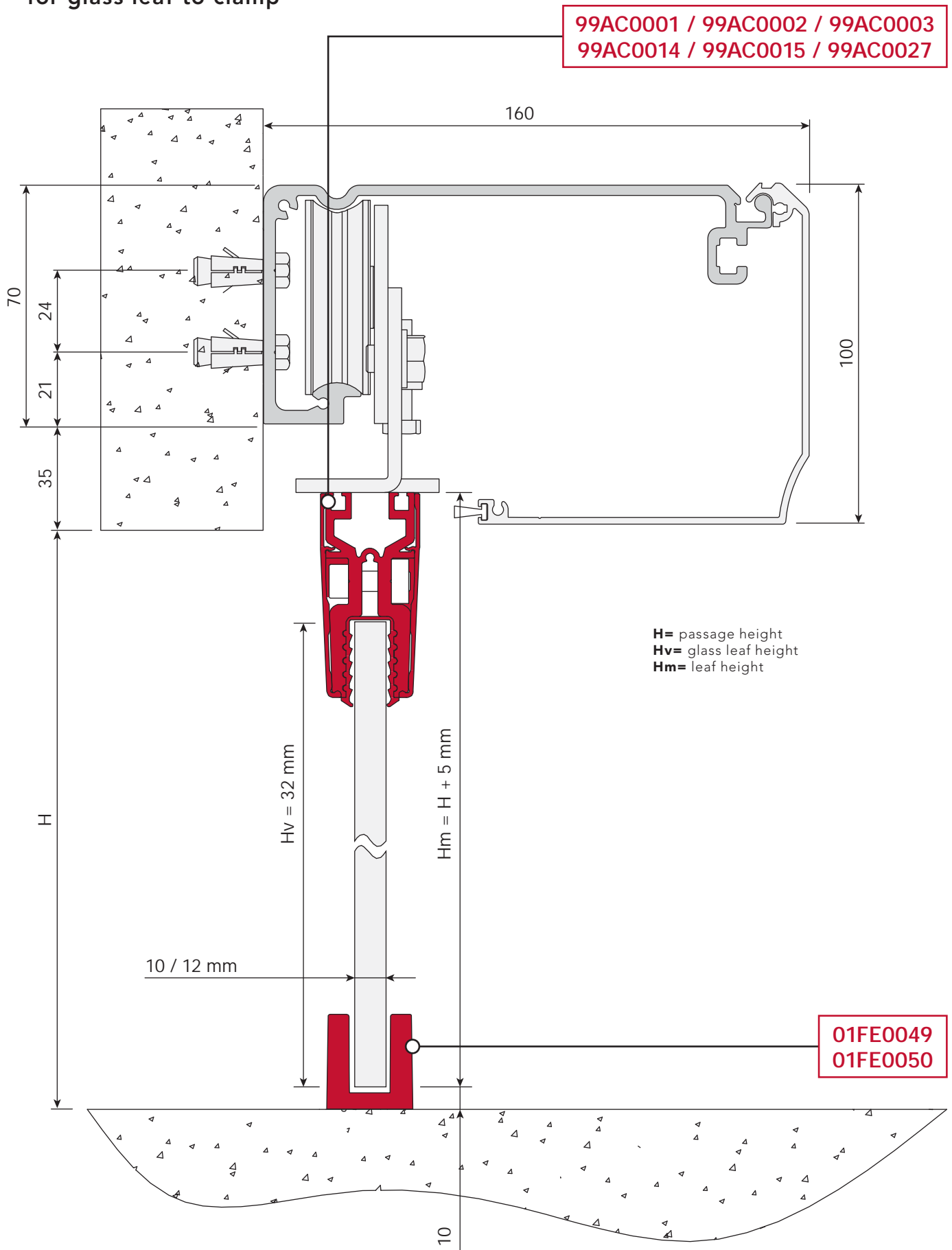



LUCE R



TÜV Thüringen
certification



redundant sliding doors for escape routes

Access points that are also used as escape routes within a public or private location require an operator designed to comply fully with regulations, ensuring safety and reliability. The Luce R automatic sliding door operator has a control unit with double electronic control and a double-winding motor, ensuring that the door will open in any situation, even when there is no power. The special TÜV-certified operation enables the operator to be installed without the need for other wired safety or anti-panic systems in the frame. Available in single-leaf (up to 140 kg) or double-leaf (up to 120+120 kg) versions.



LUCE R



download LUCE R instructions and certificates

www.myoneautomation.com

Operator for sliding doors designed to ensure maximum safety, reliability and above all certified (TÜV) operation without the need to install anti-panic devices in the frame. The operator has a double-winding brushless motor and integrated control unit with double electronic control. Every 24 hours the control unit runs functional tests on all electronic parts and safety systems to ensure that the door opens at any time in an emergency. Continuous operation guaranteed.

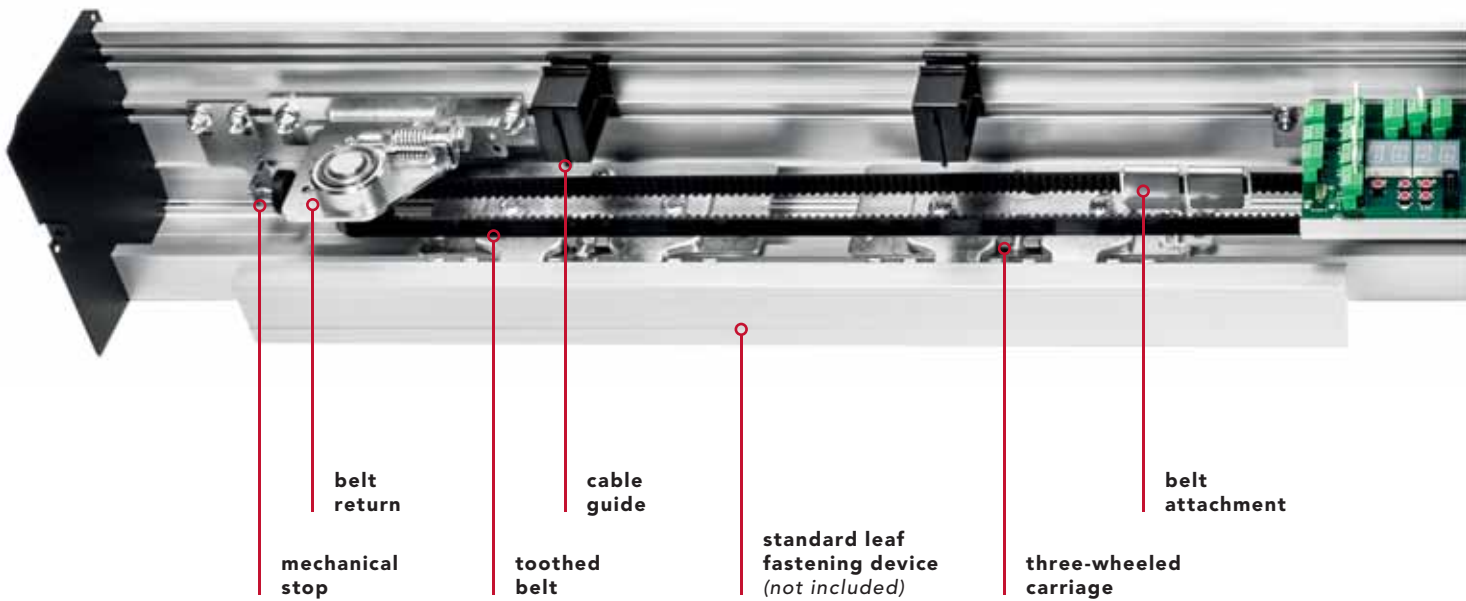

technical data

power supply	full range 100÷240 Vac 50/60 Hz
power consumption	70 W
power consumption in stand-by	10 W
accessories power supply	24 Vdc = / 1 A max
maximum speed 1 door	0.7 m/s
maximum speed 2 doors	1.4 m/s
maximum load 1 door	140 kg
maximum load 2 doors	120 + 120 kg
type and frequency of use	continuous operation = 100%
operating temperature	-15°C / +50°C
protection degree	IP20
data backup memory	standard micro SD



1 leaf
max. weight
140 kg



2 leaves
max. weight
120 + 120 kg

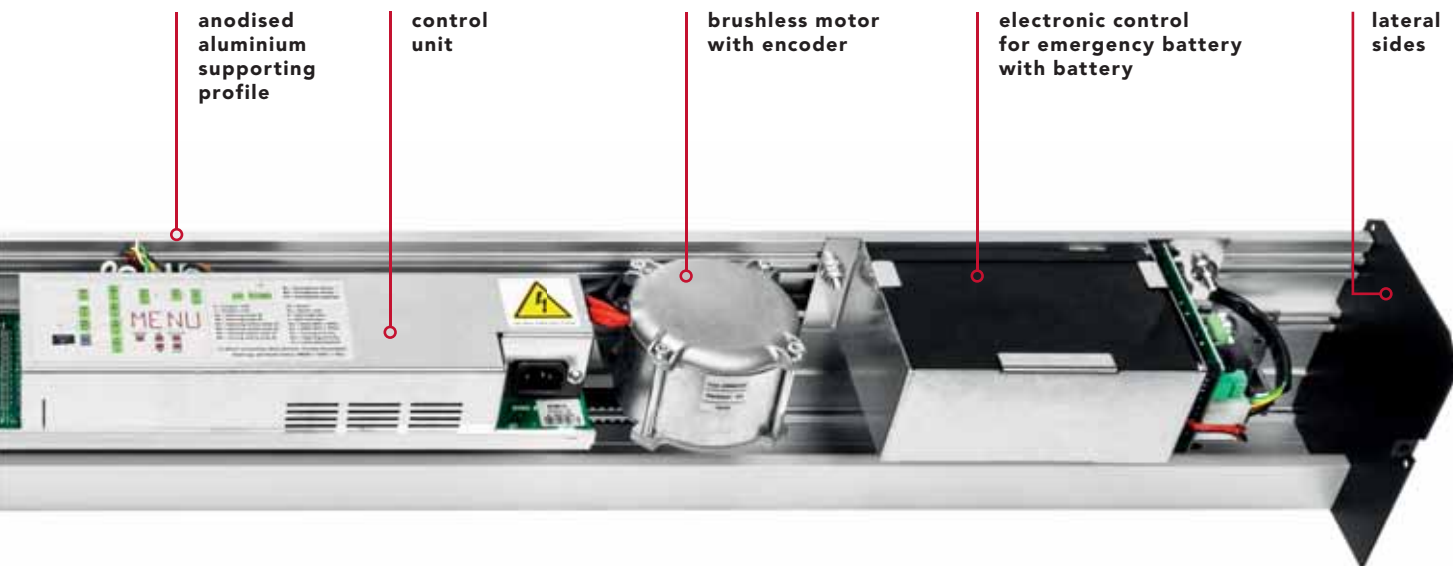

redundant preassembled

*The values of the passage size (A) and of the leaf are indicative and include an overlap of around 50 mm.

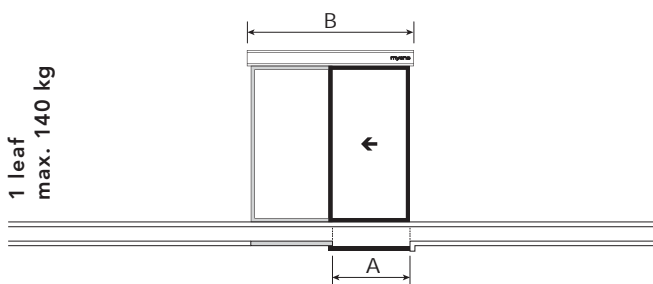

1 leaf
max. 140 kg

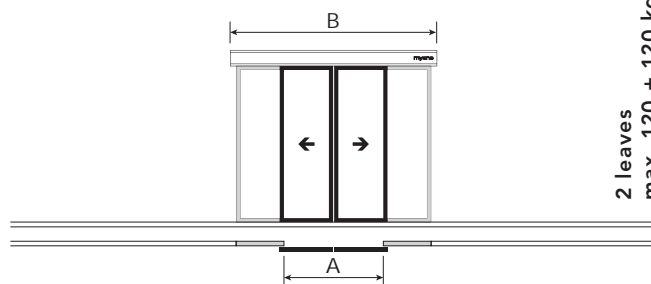

2 leaves
max. 120 + 120 kg

	A	B
LUCER1901	900 mm	1900 mm
LUCER2101	1000 mm	2100 mm
LUCER2501	1200 mm	2500 mm
LUCER2901	1400 mm	2900 mm
LUCER3301	1600 mm	3300 mm
LUCER3701	1800 mm	3700 mm
LUCER4201	2000 mm	4200 mm
LUCER5001	2450 mm	5000 mm
LUCER6501	3100 mm	6500 mm

	A	B
LUCER1902	900 mm	1900 mm
LUCER2102	1000 mm	2100 mm
LUCER2502	1200 mm	2500 mm
LUCER2902	1400 mm	2900 mm
LUCER3302	1600 mm	3300 mm
LUCER3702	1800 mm	3700 mm
LUCER4202	2000 mm	4200 mm
LUCER5002	2450 mm	5000 mm
LUCER6502	3100 mm	6500 mm

the preassembled operator is made up of:

control unit | brushless motor with encoder | electronic control for emergency battery with battery | three-wheeled sliding carriages | anodised aluminium supporting profile and cover | belt return | mechanical end-stop | belt | cable guide | screw kit | lateral sides



mandatory components for TÜV Thüringen certification



discover the Myone frame range

pg. 106



31RD0002

Opening and safety autotest double technology sensor for redundant automation devices.
- EN 16005. DIN 18650. IP54



31RD0004

Opening and safety autotest double technology sensor for redundant automation devices.
- EN 16005. DIN 18650. IP54

framed door accessories - commercial frame



01AL0030 - 1000 mm
01AL0031 - 1500 mm
01AL0032 - 2000 mm
01AL0035 - 3000 mm

Aluminium floor guide for one leaf.



01FE0018

Floor guide slider.



01AL0008 - 1000 mm
01AL0009 - 1500 mm
01AL0010 - 2000 mm
01AL0015 - 3000 mm
01AL0016 - 5670 mm
01AL0020 - 6500 mm

Standard leaf fastening device complete with fixing brackets for the carriage.



90RM0053

Pair of leaf fixing brackets (1 leaf).

glass door accessories - fastening set for glass leaves with pre-drilled holes



99AC0004 - 1000 mm
99AC0005 - 1500 mm
99AC0006 - 2000 mm
99AC0016 - 3000 mm
99AC0021 - 5670 mm
99AC0029 - 6500 mm

Fastening set for glass leaf (10-12 mm) with pre-drilled holes.



01FE0049

Glass door slider.
- 6 piece pack



01FE0050

Glass door stainless steel slider.



01GM0001

Adhesive gasket for glass leaf.
- 6 m pack

glass door accessories - fastening clamp set for glass leaves



99AC0001 - 1000 mm
99AC0002 - 1500 mm
99AC0003 - 2000 mm
99AC0014 - 3000 mm
99AC0015 - 5670 mm
99AC0027 - 6500 mm

Fastening clamp set for glass leaf (10-12 mm thickness).



01FE0049

Glass door slider.
- 6 piece pack



01FE0050

Glass door stainless steel slider.



01GM0001

Adhesive gasket for glass leaf.
- 6 m pack



accessories



99EB0004

Bistable electromechanical lock kit with release cord.



AQA.R

Digital selector device for Luce R.



AQA.CARD

Transponder card with NFC technology.
- 10 piece pack

other accessories available on page 100

operator cross-section
technical drawing

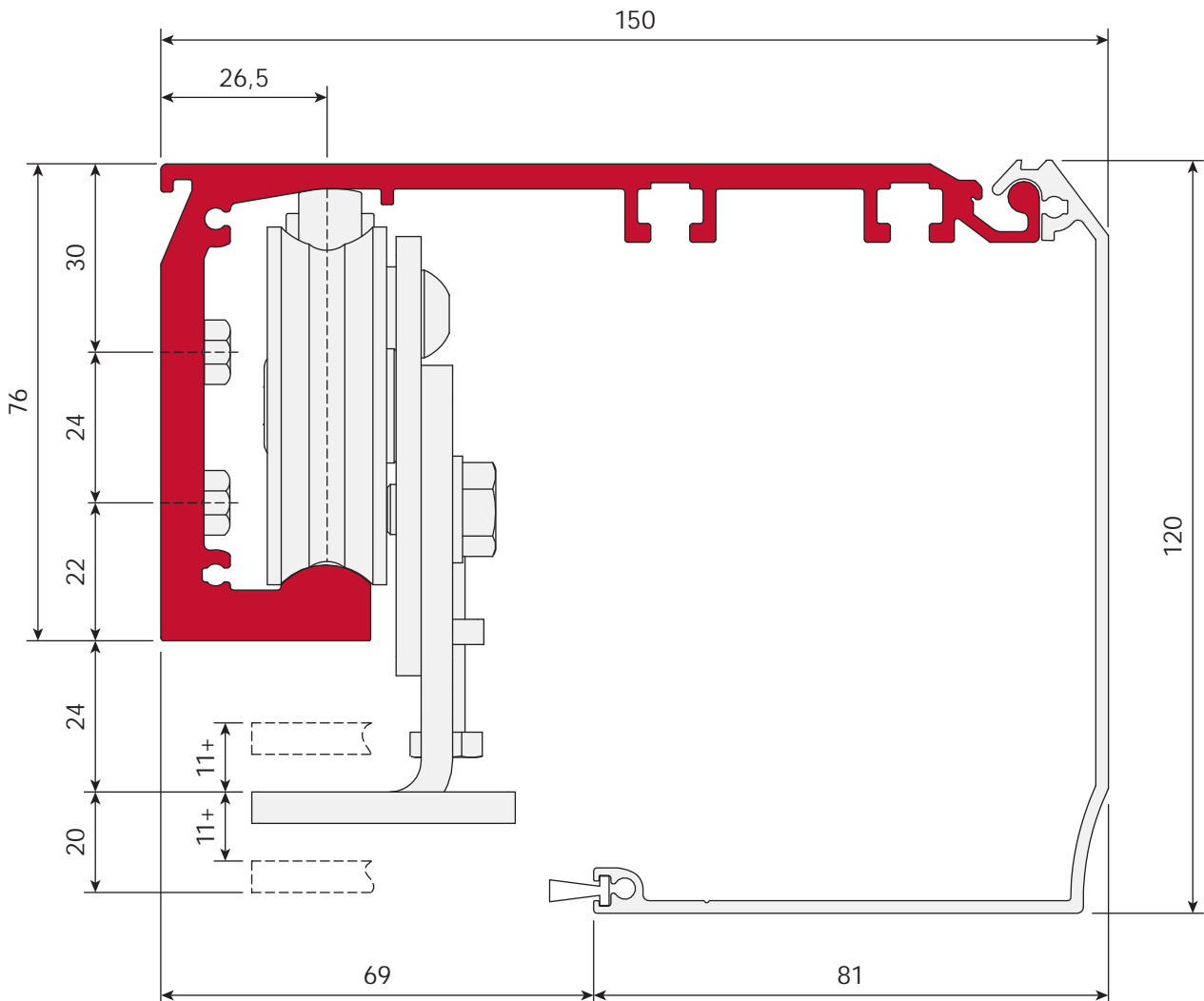



entrance with M30 myone frame

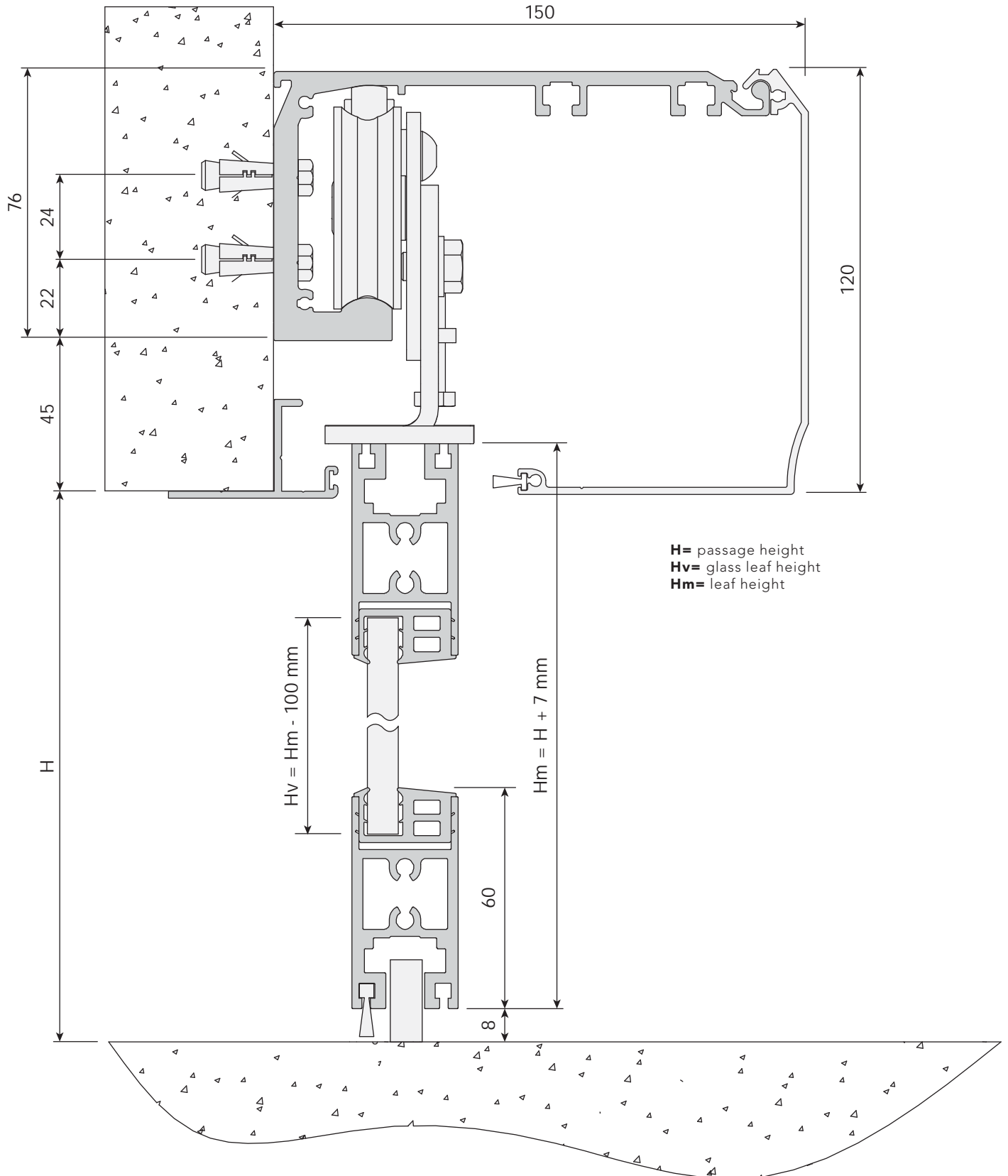



entrance with commercial profiles

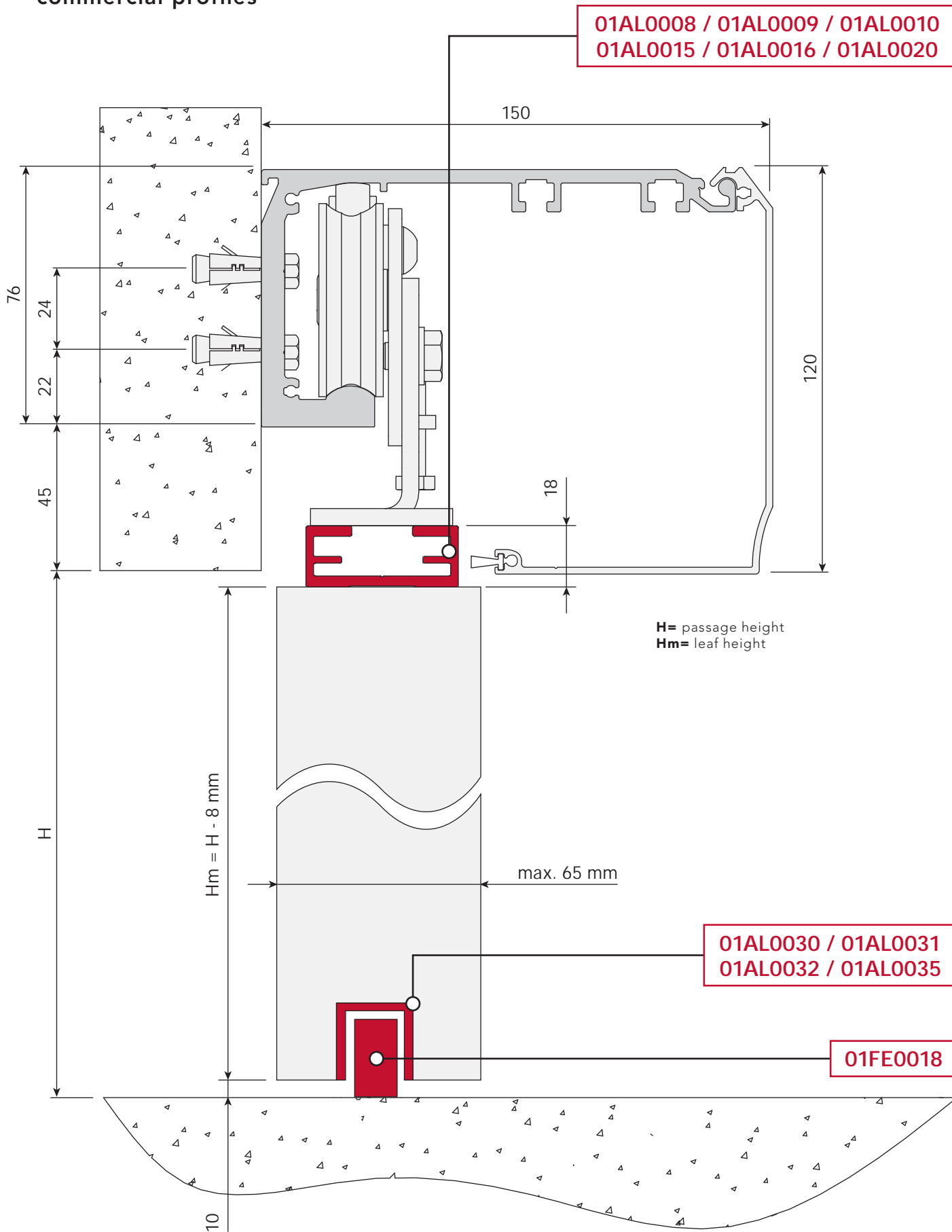

H= passage height
Hm= leaf height

$H_m = H - 8 \text{ mm}$

max. 65 mm

01AL0030 / 01AL0031
01AL0032 / 01AL0035

01FE0018



entrance with fastening set for glass leaf with pre-drilled holes

99AC0004 / 99AC0005 / 99AC0006
99AC0016 / 99AC0021 / 99AC0029

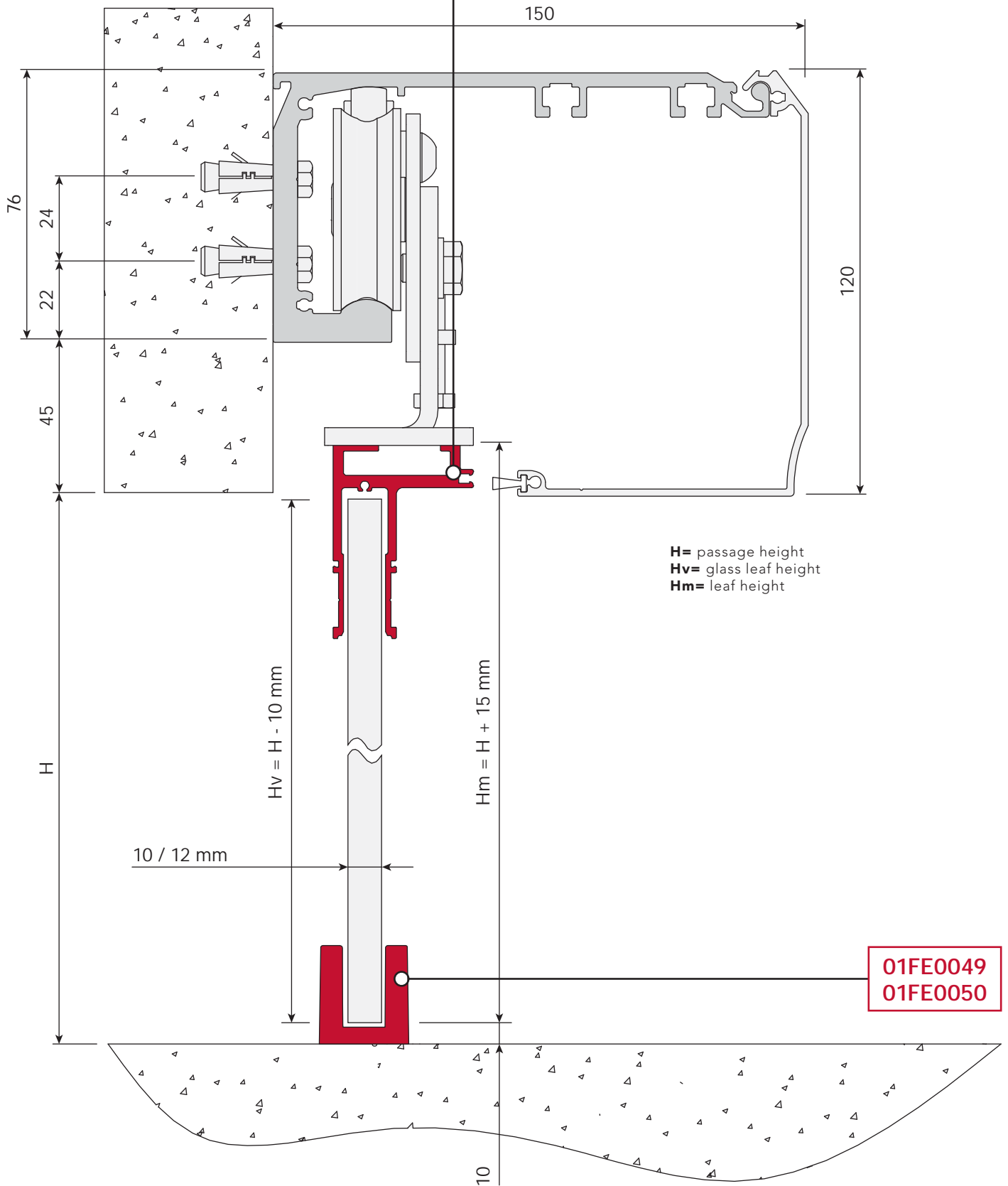



entrance with fastening set for glass leaf to clamp

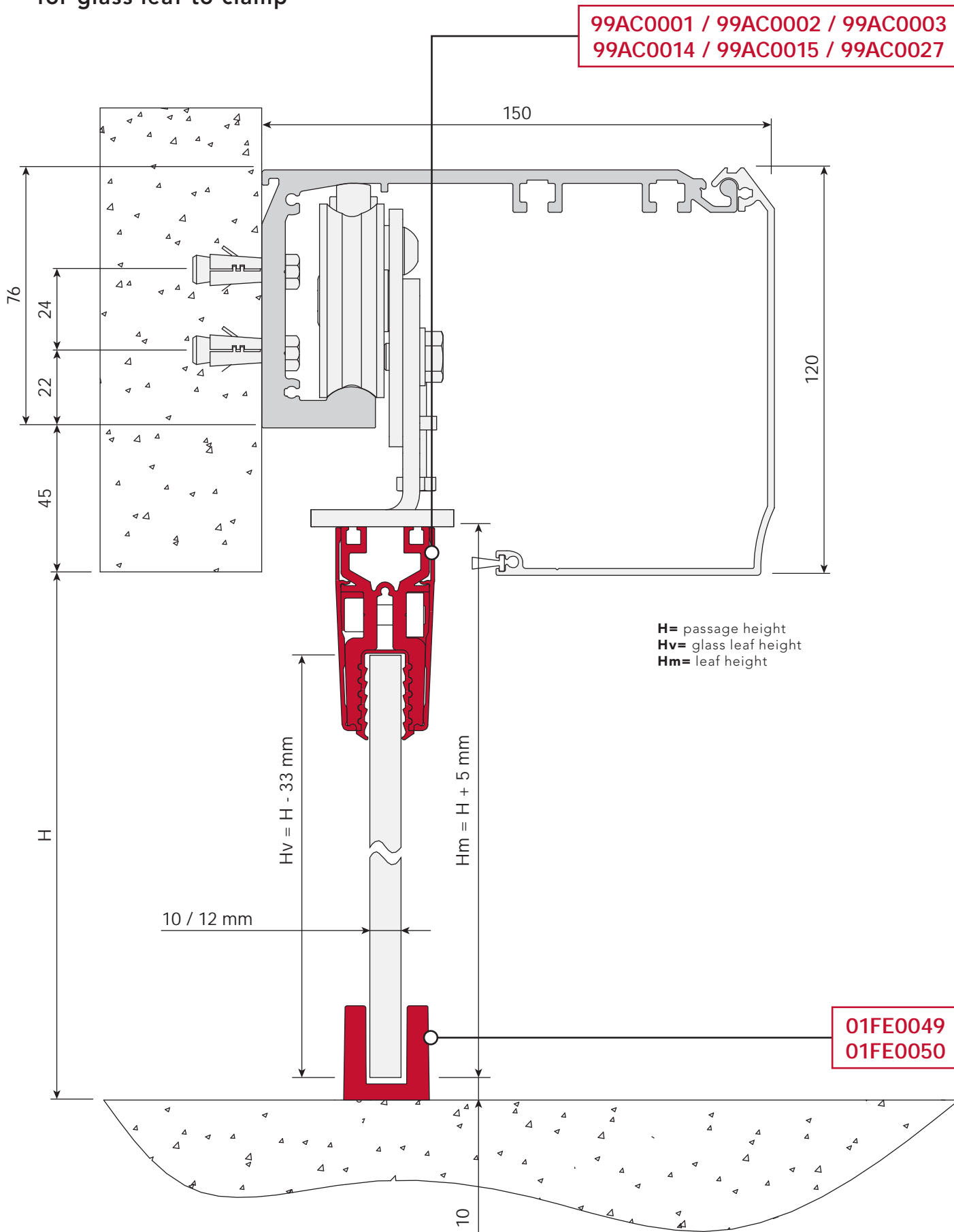



LUCE WORKS



watertight sliding doors

The Works series models represent the ideal solution in those contexts, in which weather conditions are particularly harsh, for example on boats, or where a high level of hygiene is required. Components and screws are entirely made of AISI 316L stainless steel, which guarantees the maximum resistance. The box containing the motor and the electronics is IP65 rated and ensures maximum water and dust tightness. Available in single-leaf (up to 200 kg) or double-leaf (up to 130+130 kg) versions.

LUCE WORKS



↓ download LUCE WORKS instructions and certificates

www.myoneautomation.com

Operator for sliding doors with three-wheeled carriages, which ensures a high leaf stability and facilitates the adjustment both in height and in depth. Components and screws are entirely made of AISI 316L stainless steel. The motor enclosure, the control unit, and the battery are **IP65-certified**. The control unit is equipped with a LED alphanumeric display, a full range switching power supply (100 - 240 V 50/60 Hz) and a battery charger. The presence of a USB connector allows you to quickly and easily update the firmware as well as instantly copy operating parameters and logics to a new system. Continuous operation guaranteed.

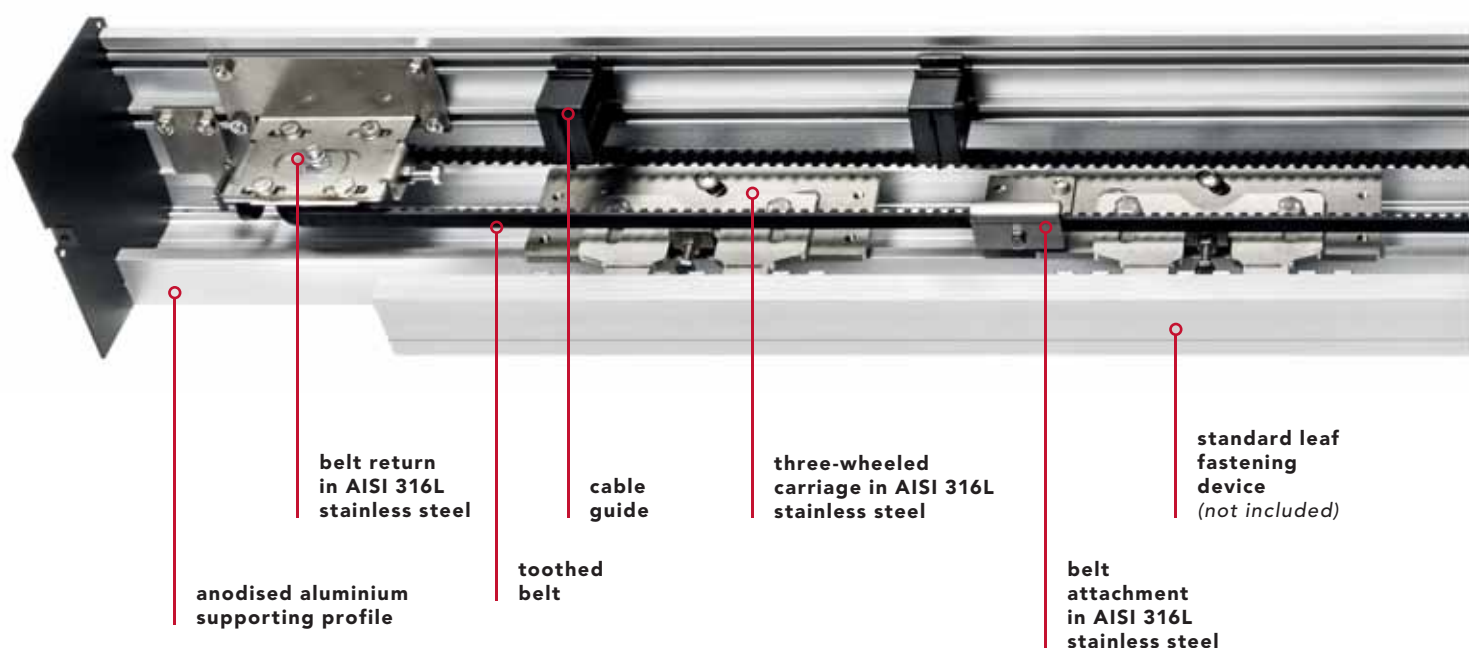

technical data

power supply	full range 100÷240 Vac 50/60 Hz
power consumption	70 W
power consumption in stand-by	3 W
accessories power supply	24 Vdc = / 1 A max
maximum speed 1 door	0.8 m/s
maximum speed 2 doors	1.6 m/s
maximum load 1 door	200 kg
maximum load 2 doors	130 + 130 kg
type and frequency of use	continuous operation = 100%
operating temperature	-15°C / +50°C
protection degree	IP65
data backup memory	USB flash drive



1 leaf
max. weight
200 kg



2 leaves
max. weight
130 + 130 kg

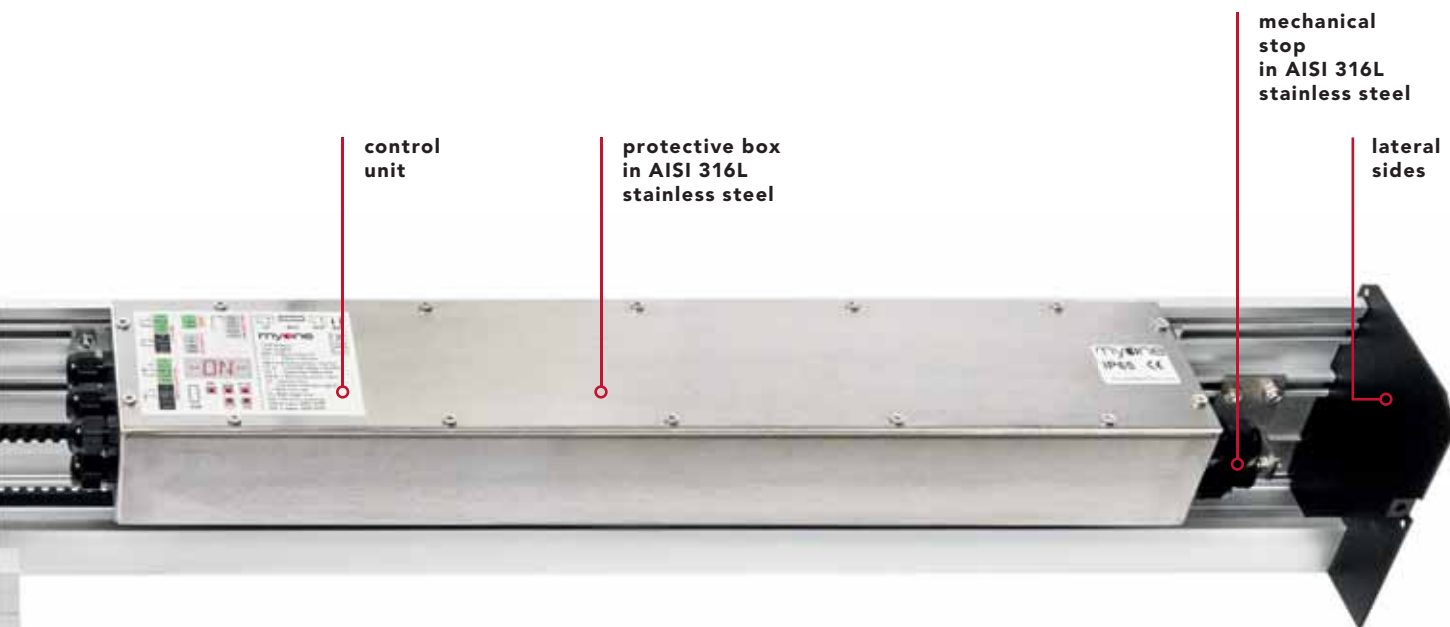

watertight preassembled

*The values of the passage size (A) and of the leaf are indicative and include an overlap of around 50 mm.

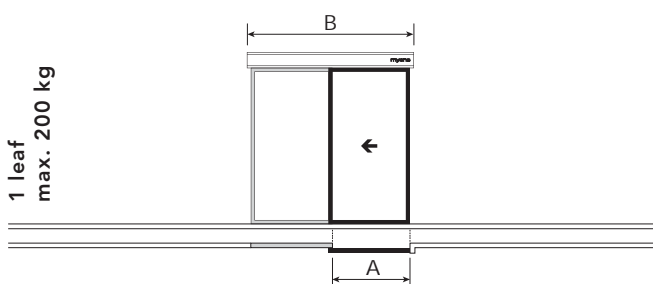

1 leaf
max. 200 kg

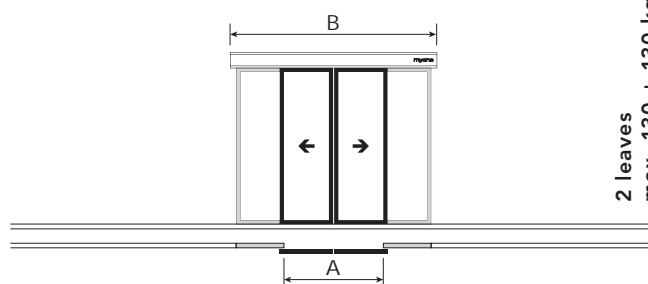

2 leaves
max. 130 + 130 kg

	A	B
LUCEW1901	900 mm	1900 mm
LUCEW2101	1000 mm	2100 mm
LUCEW2501	1200 mm	2500 mm
LUCEW2901	1400 mm	2900 mm
LUCEW3301	1600 mm	3300 mm
LUCEW3701	1800 mm	3700 mm
LUCEW4201	2000 mm	4200 mm
LUCEW5001	2450 mm	5000 mm
LUCEW6501	3100 mm	6500 mm

	A	B
LUCEW1902	900 mm	1900 mm
LUCEW2102	1000 mm	2100 mm
LUCEW2502	1200 mm	2500 mm
LUCEW2902	1400 mm	2900 mm
LUCEW3302	1600 mm	3300 mm
LUCEW3702	1800 mm	3700 mm
LUCEW4202	2000 mm	4200 mm
LUCEW5002	2450 mm	5000 mm
LUCEW6502	3100 mm	6500 mm

the preassembled operator is made up of:

control unit | gear motor with encoder | three-wheeled sliding carriages made of AISI 316L stainless steel | anodised aluminium supporting profile and cover | belt return made of AISI 316L stainless steel | mechanical end-stop made of AISI 316L stainless steel | belt | cable guide | A4 screw kit | lateral sides

kit for doors with one sliding leaf

KLUCE01W

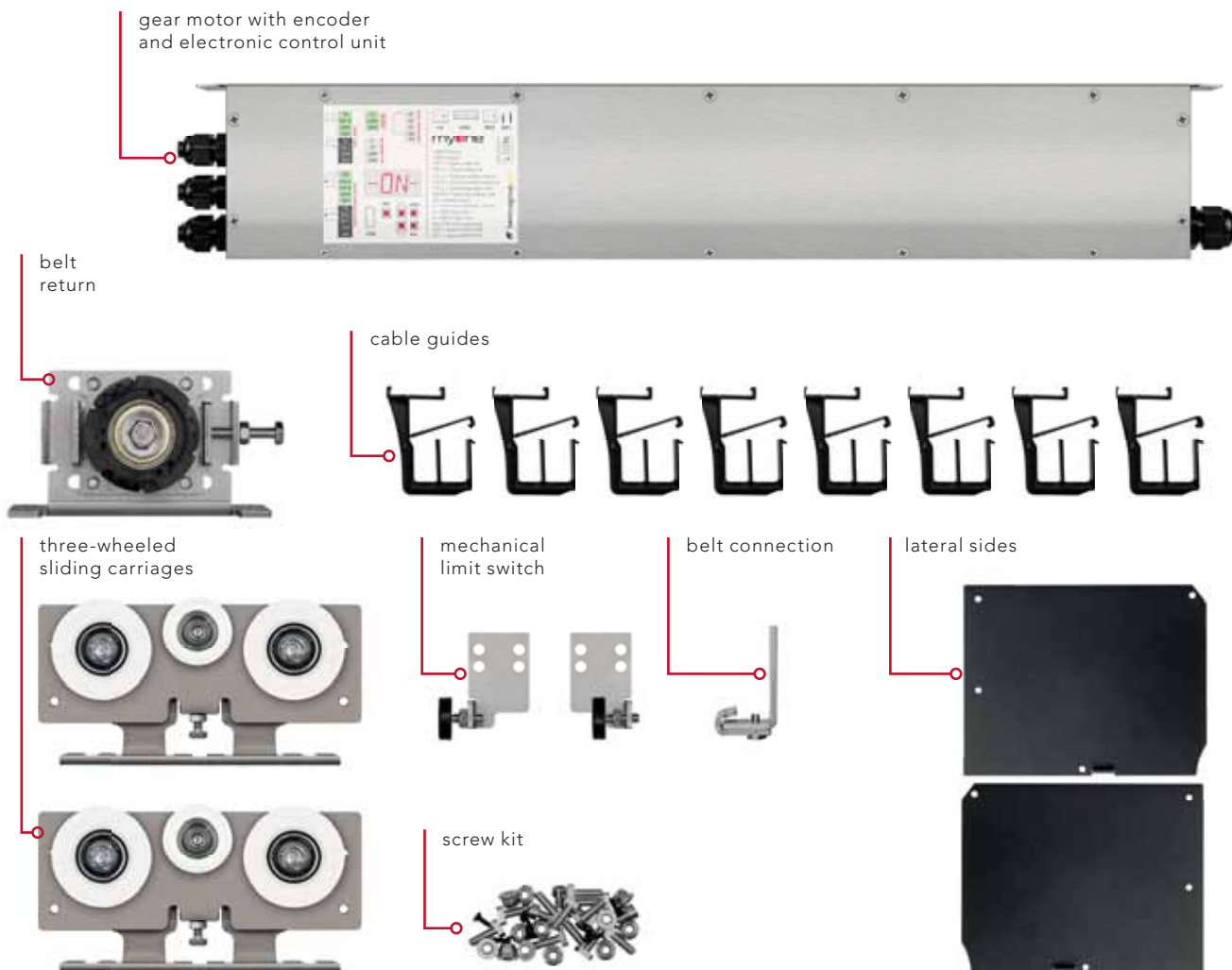
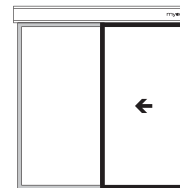

LUCE WORKS - accessories to complete the kit



01AL0029 - 4,2 m
01AL0037 - 6,5 m

Anodised aluminium supporting profile.
- 4.32 kg/m



01AL0006 - 4,2 m
01AL0023 - 6,5 m

Anodised aluminium cover.
- 1.52 kg/m



32CG0001 - 50 m
32CG0004 - 1 m

Belt.



011M0007

Packaging kit with headers.

kit for doors with two sliding leaves

KLUCE02W

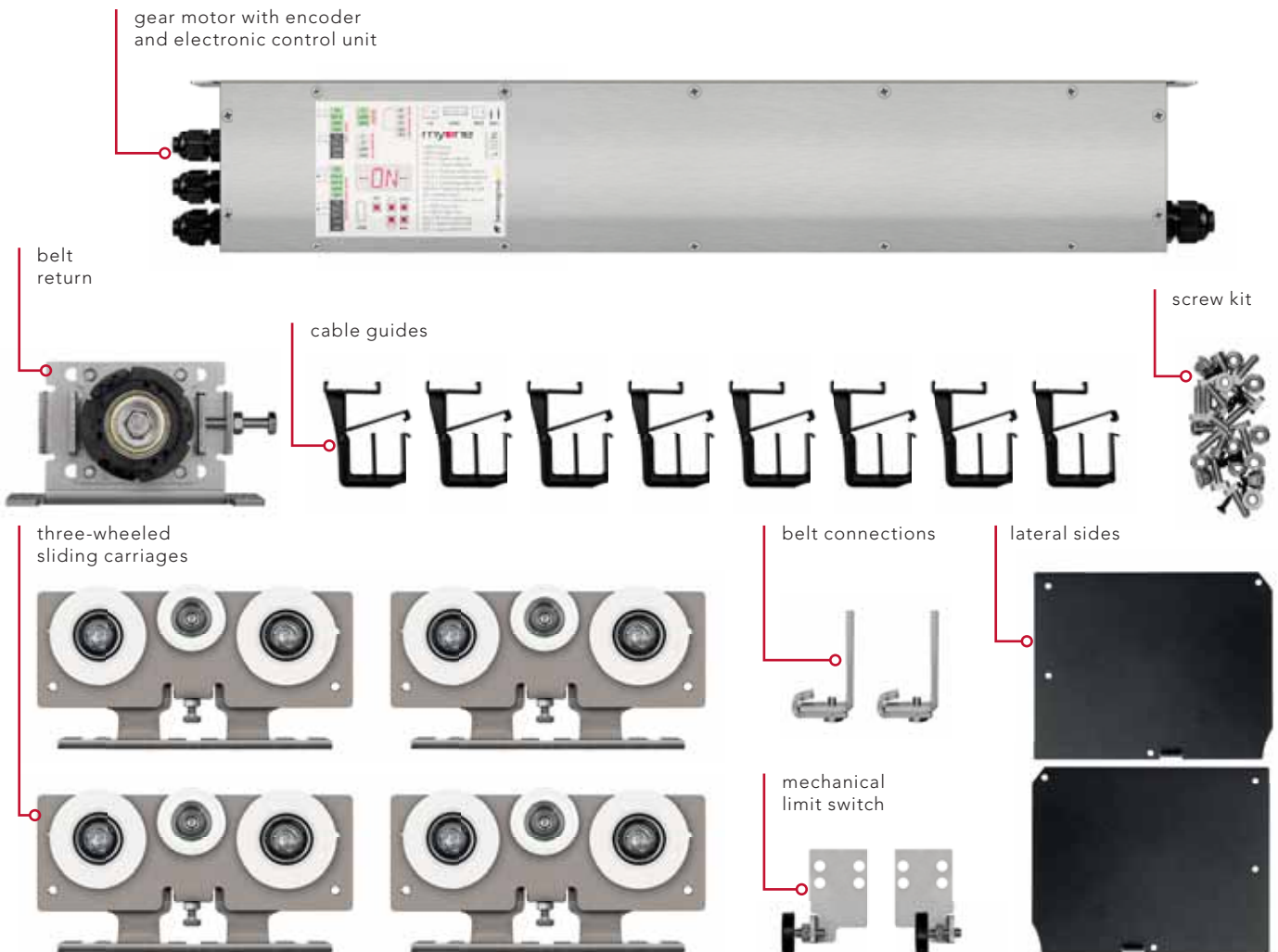
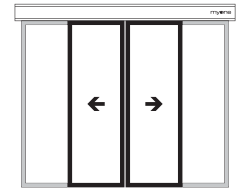

LUCE WORKS - accessories to complete the kit



01AL0029 - 4,2 m
01AL0037 - 6,5 m

Anodised aluminium supporting profile.
- 4.32 kg/m



01AL0006 - 4,2 m
01AL0023 - 6,5 m

Anodised aluminium cover.
- 1.52 kg/m



32CG0001 - 50 m
32CG0004 - 1 m

Belt.



011M0007

Packaging kit with headers.

discover the Myone frame range

pg. 106

framed door accessories - commercial frame



01AL0030 - 1000 mm
01AL0031 - 1500 mm
01AL0032 - 2000 mm
01AL0035 - 3000 mm

Aluminium floor guide for one leaf.



01FE0018

Floor guide slider.



01AL0008 - 1000 mm
01AL0009 - 1500 mm
01AL0010 - 2000 mm
01AL0015 - 3000 mm
01AL0016 - 5670 mm
01AL0020 - 6500 mm

Standard leaf fastening device complete with fixing brackets for the carriage.



90RM0053

Pair of leaf fixing brackets (1 leaf).

glass door accessories - fastening set for glass leaves with pre-drilled holes



99AC0004 - 1000 mm
99AC0005 - 1500 mm
99AC0006 - 2000 mm
99AC0016 - 3000 mm
99AC0021 - 5670 mm
99AC0029 - 6500 mm

Fastening set for glass leaf (10-12 mm) with pre-drilled holes.



01FE0049

Glass door slider.
 - 6 piece pack



01FE0050

Glass door stainless steel slider.



01GM0001

Adhesive gasket for glass leaf.
 - 6 m pack

glass door accessories - fastening clamp set for glass leaves



99AC0001 - 1000 mm
99AC0002 - 1500 mm
99AC0003 - 2000 mm
99AC0014 - 3000 mm
99AC0015 - 5670 mm
99AC0027 - 6500 mm

Fastening clamp set for glass leaf (10-12 mm thickness).



01FE0049

Glass door slider.
 - 6 piece pack



01FE0050

Glass door stainless steel slider.



01GM0001

Adhesive gasket for glass leaf.
 - 6 m pack

accessories



31PE0004

Photoelectric sensor.
- IP64

99BA0004

Pre-wired emergency battery kit.

other accessories available on page 100

operator cross-section
technical drawing

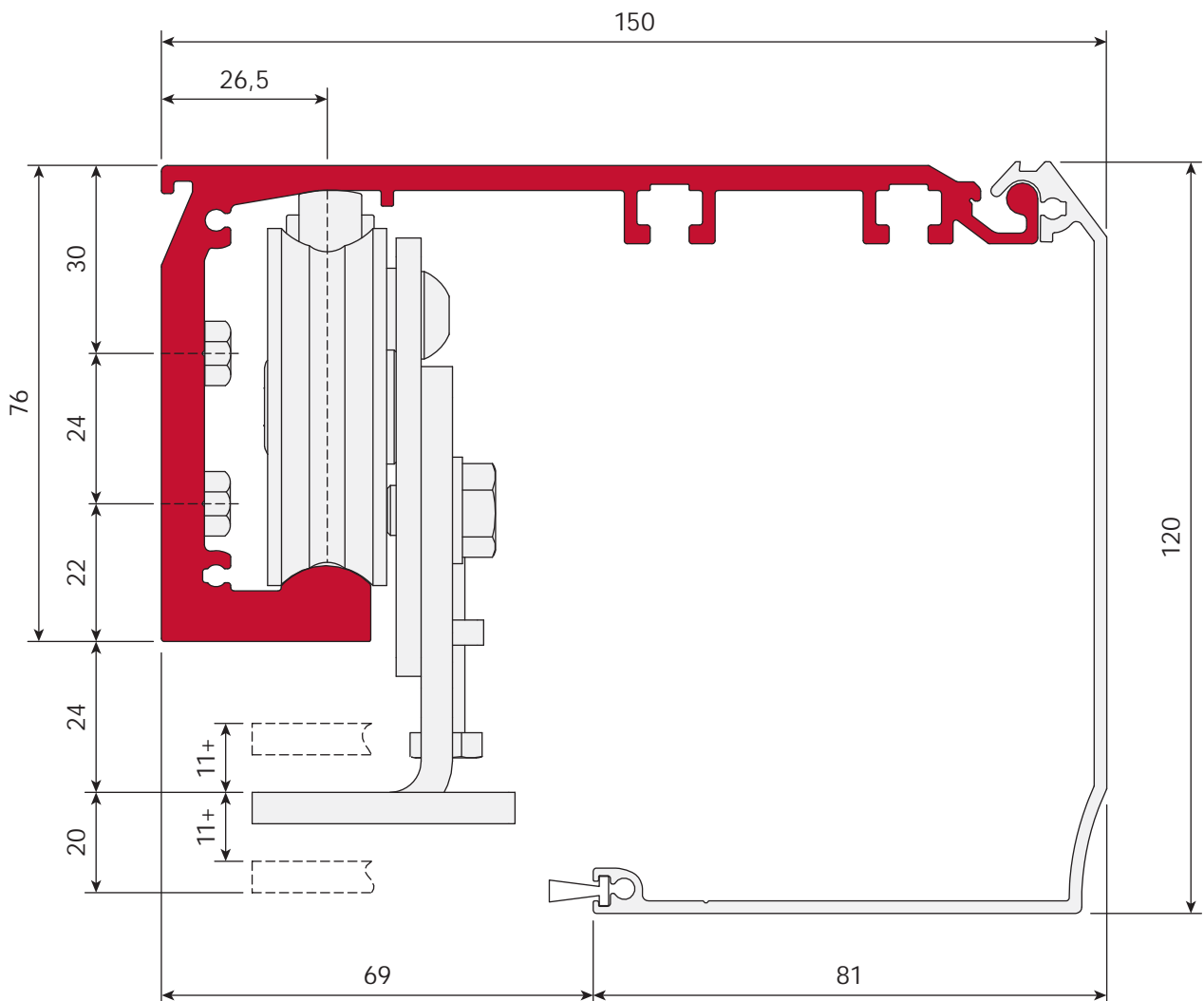

entrance with M30
myone frame

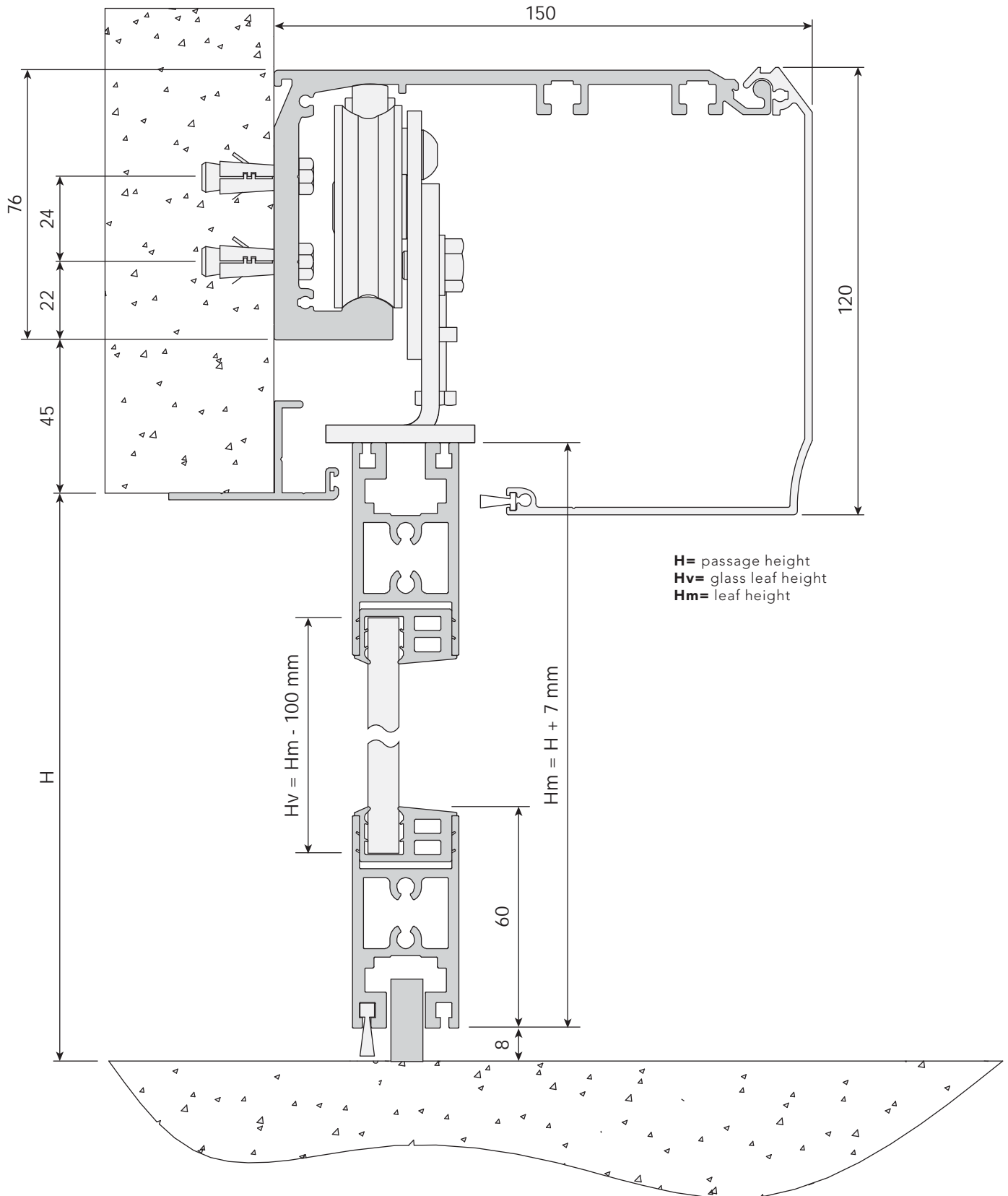

entrance with commercial profiles

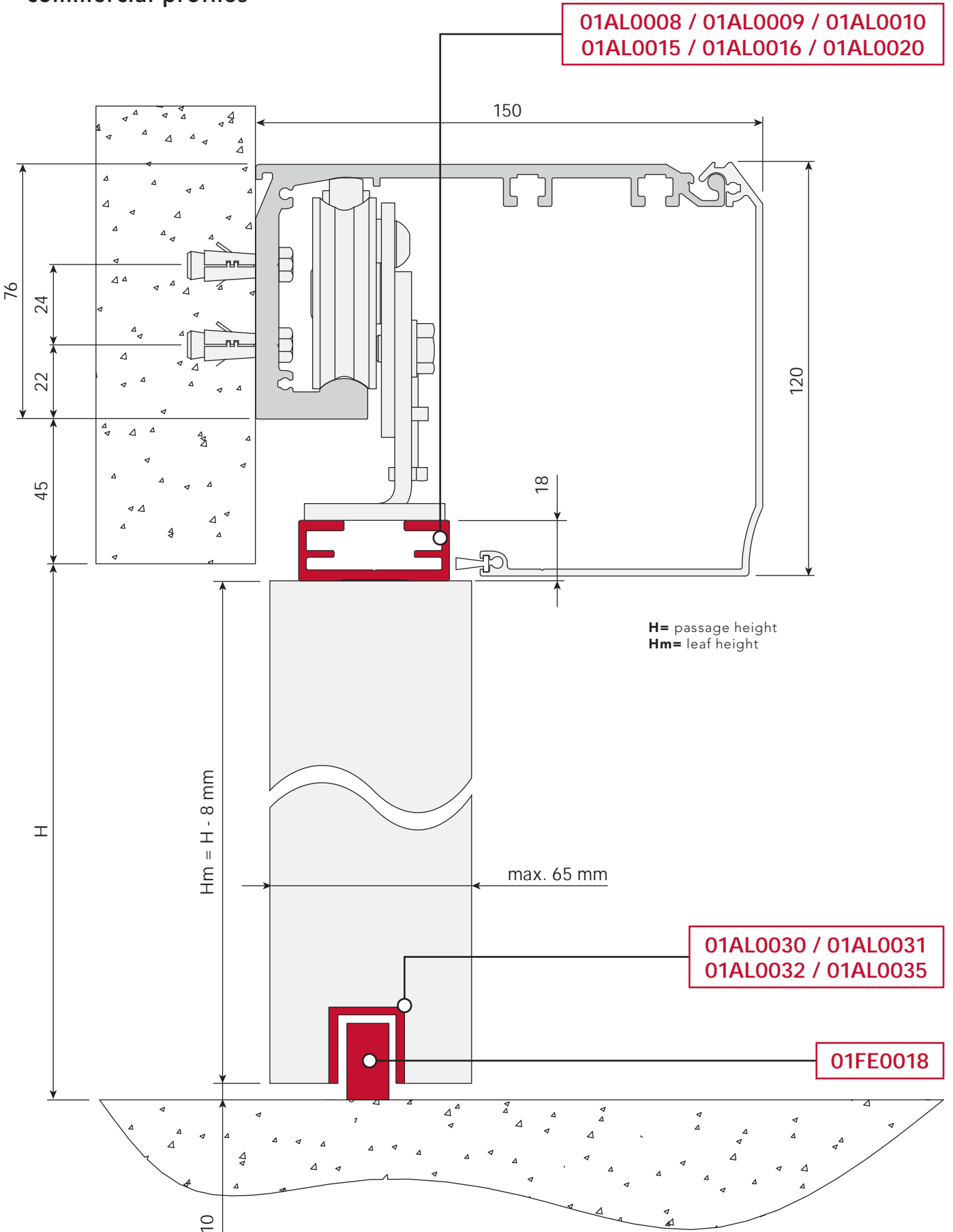

entrance with fastening set
for glass leaf with pre-drilled holes

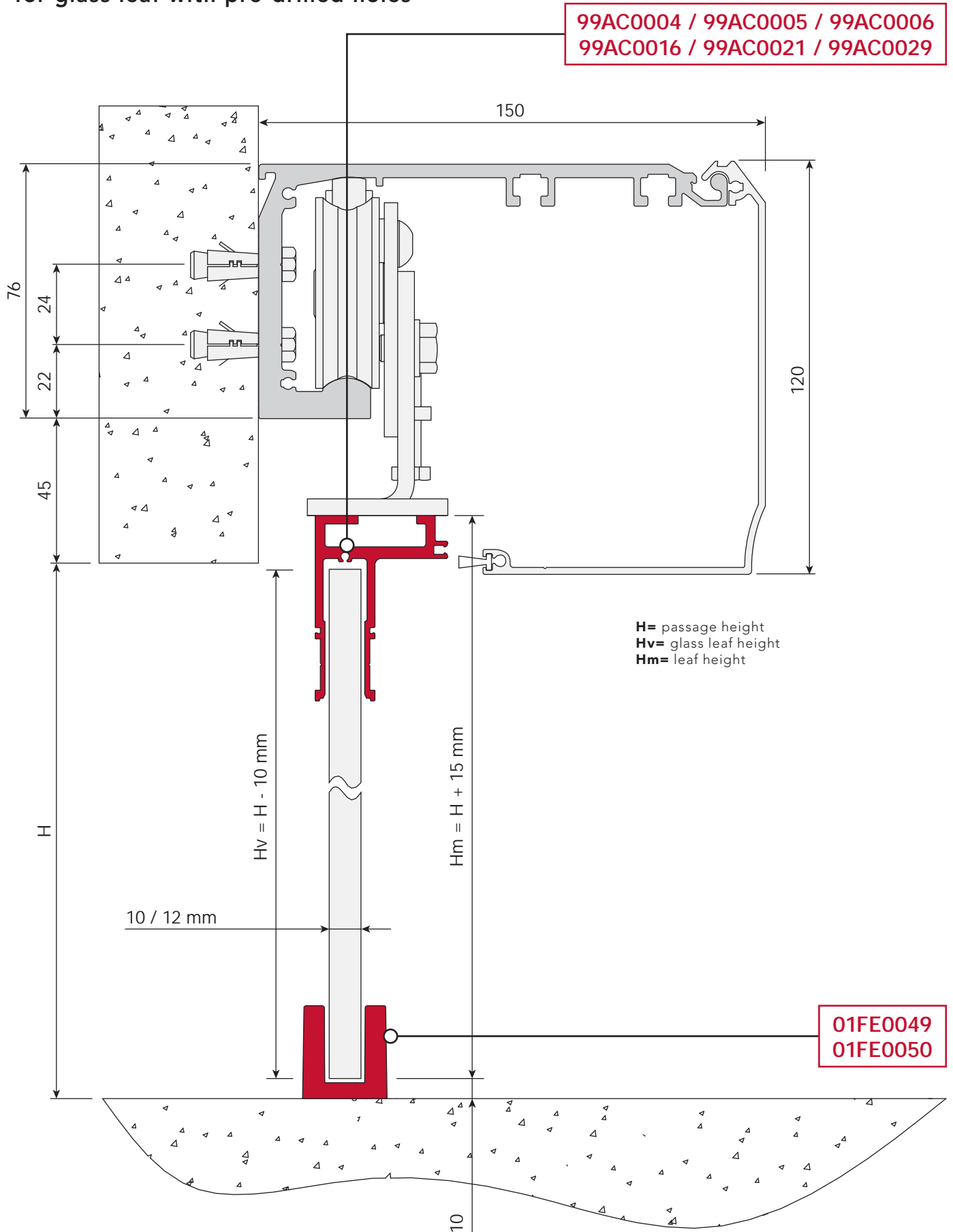

entrance with fastening set
for glass leaf to clamp

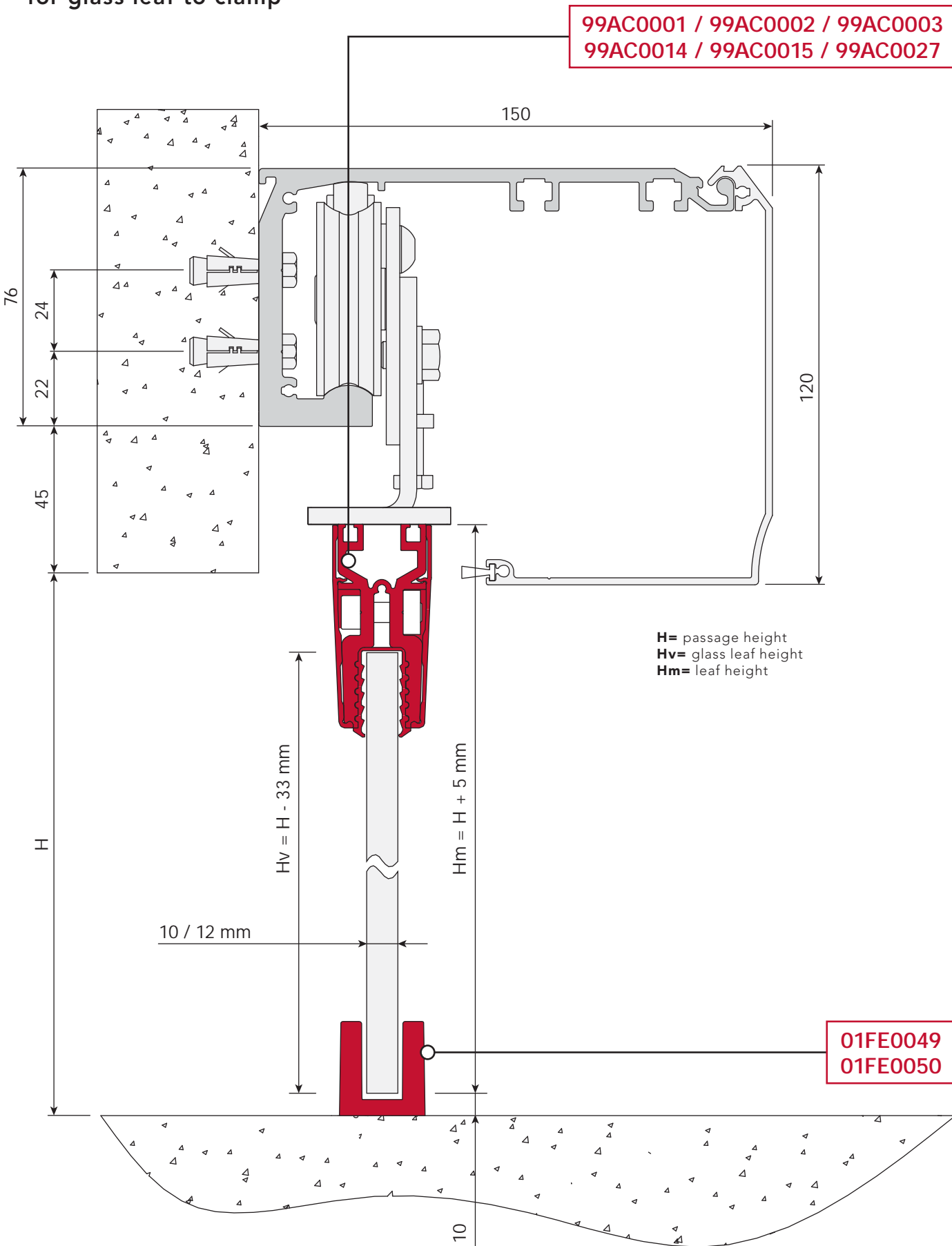



LUCE WORKS P



myone



**certified watertight
sliding doors
for use in water**

The leaves of the Works P models are designed to be immersed in water, e.g. swimming pools or spas. Nuts, bolts, and components are made of AISI 316L stainless steel, which ensures excellent resistance. The IP65 motor enclosure is water- and dust-tight, whereas the electronic part is housed externally in a plastic IP56 box. Available in the single leaf version (up to 200 kg) or double leaf version (up to 130+130 kg).

LUCE WORKS P



download LUCE WORKS P
instructions
and certificates

www.myoneautomation.com

Automation for sliding doors developed for immersing the leaves in water in compliance with the IEC 60364-7-702 standard (Requirements for special installations or locations – Swimming pools and other basins). Nuts, bolts and components are made of AISI 316L stainless steel. The motor enclosure is **IP65-certified**, whereas the control unit is in an external IP56 box (10 m extension cable provided). The automation is equipped with a control unit with a LED alphanumeric display, full-range switching power supply (100-240 V 50/60 Hz), and battery charger. A USB connector allows for easily and quickly updating the firmware as well as quickly duplicating parameters and operating logic in a new system. Continuous operation guaranteed.

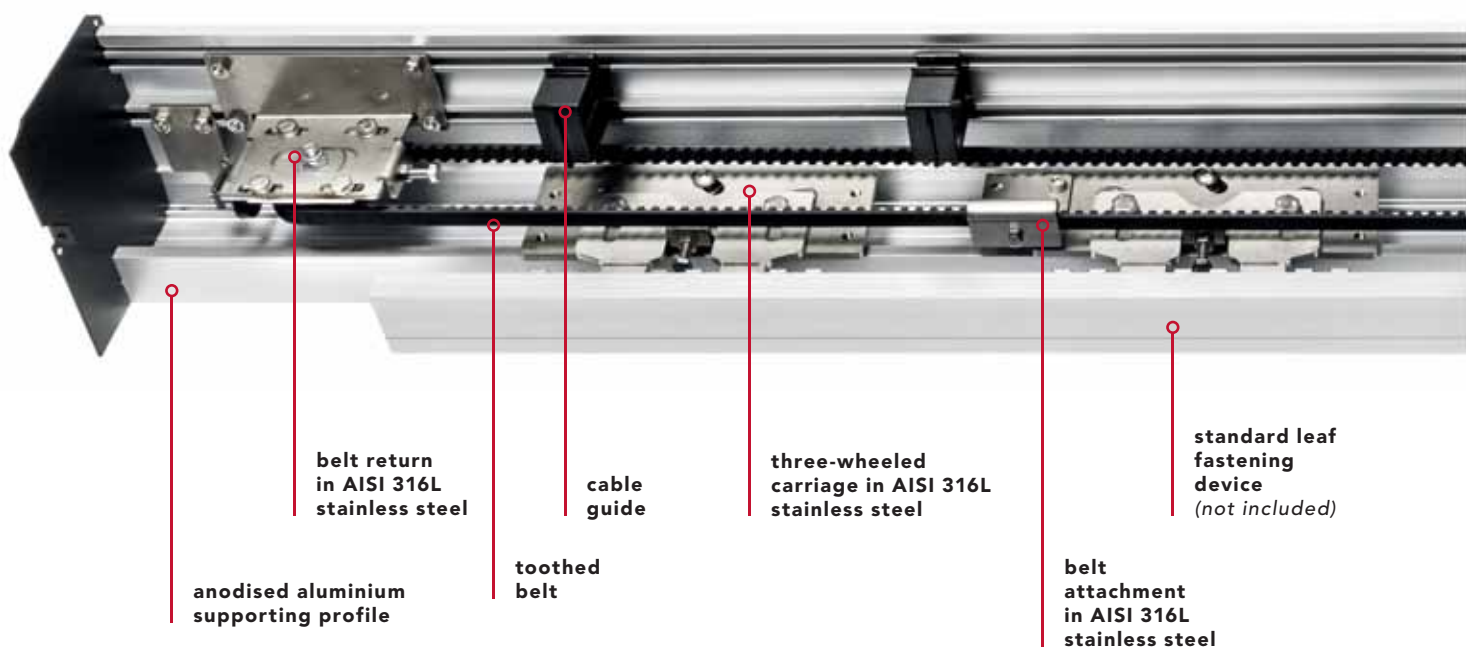

technical data

power supply	full range 100÷240 Vac 50/60 Hz
power consumption	70 W
power consumption in stand-by	3 W
accessories power supply	24 Vdc = / 1 A max
maximum speed 1 door	0.8 m/s
maximum speed 2 doors	1.6 m/s
maximum load 1 door	200 kg
maximum load 2 doors	130 + 130 kg
type and frequency of use	continuous operation = 100%
operating temperature	-15°C / +50°C
protection degree	IP65
data backup memory	USB flash drive



1 leaf
max. weight
200 kg



2 leaves
max. weight
130 + 130 kg



external control unit:

- remote installation in an IP56 box
- output with a SELV insulation in compliance with specific standards for swimming pools

protective box in AISI 316L stainless steel

mechanical stop in AISI 316L stainless steel

lateral sides

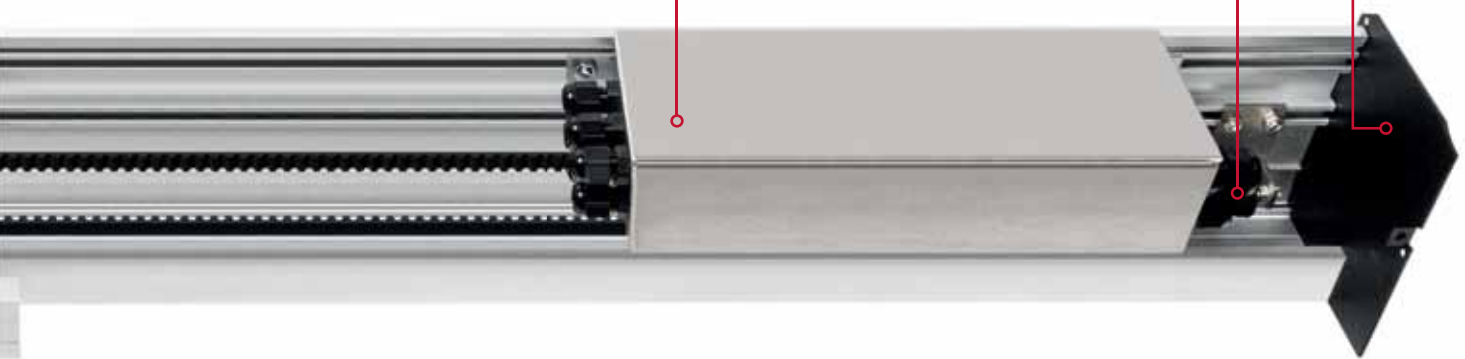

watertight preassembled

**The values of the passage size (A) and of the leaf are indicative and include an overlap of around 50 mm.*

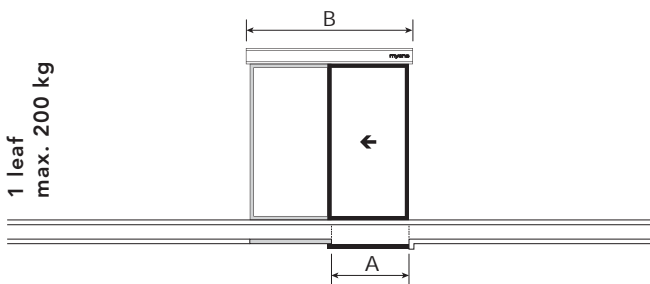

1 leaf
max. 200 kg

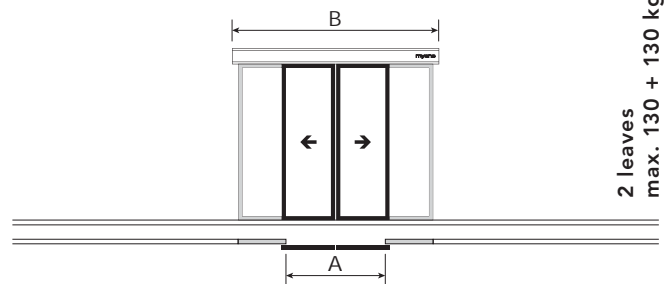

2 leaves
max. 130 + 130 kg

	A	B
LUCEWP1901	900 mm	1900 mm
LUCEWP2101	1000 mm	2100 mm
LUCEWP2501	1200 mm	2500 mm
LUCEWP2901	1400 mm	2900 mm
LUCEWP3301	1600 mm	3300 mm
LUCEWP3701	1800 mm	3700 mm
LUCEWP4201	2000 mm	4200 mm
LUCEWP5001	2450 mm	5000 mm
LUCEWP6501	3100 mm	6500 mm

	A	B
LUCEWP1902	900 mm	1900 mm
LUCEWP2102	1000 mm	2100 mm
LUCEWP2502	1200 mm	2500 mm
LUCEWP2902	1400 mm	2900 mm
LUCEWP3302	1600 mm	3300 mm
LUCEWP3702	1800 mm	3700 mm
LUCEWP4202	2000 mm	4200 mm
LUCEWP5002	2450 mm	5000 mm
LUCEWP6502	3100 mm	6500 mm

the preassembled operator is made up of:

external control unit | gear motor with encoder | three-wheeled sliding carriages made of AISI 316L stainless steel | anodised aluminium supporting profile and cover | belt return made of AISI 316L stainless steel | mechanical end-stop made of AISI 316L stainless steel | belt | cable guide | A4 screw kit | lateral sides

discover the Myone frame range

pg. 106

framed door accessories - commercial frame



01AL0030 - 1000 mm
01AL0031 - 1500 mm
01AL0032 - 2000 mm
01AL0035 - 3000 mm

Aluminium floor guide for one leaf.



01FE0018
 Floor guide slider.



01AL0008 - 1000 mm **01AL0015** - 3000 mm
01AL0009 - 1500 mm **01AL0016** - 5670 mm
01AL0010 - 2000 mm **01AL0020** - 6500 mm

Standard leaf fastening device complete with fixing brackets for the carriage.



90RM0053
 Pair of leaf fixing brackets (1 leaf).

glass door accessories - fastening set for glass leaves with pre-drilled holes



99AC0004 - 1000 mm **99AC0016** - 3000 mm
99AC0005 - 1500 mm **99AC0021** - 5670 mm
99AC0006 - 2000 mm **99AC0029** - 6500 mm

Fastening set for glass leaf (10-12 mm) with pre-drilled holes.



01FE0049
 Glass door slider.
 - 6 piece pack



01FE0050
 Glass door stainless steel slider.



01GM0001
 Adhesive gasket for glass leaf.
 - 6 m pack

glass door accessories - fastening clamp set for glass leaves



99AC0001 - 1000 mm **99AC0014** - 3000 mm
99AC0002 - 1500 mm **99AC0015** - 5670 mm
99AC0003 - 2000 mm **99AC0027** - 6500 mm

Fastening clamp set for glass leaf (10-12 mm thickness).



01FE0049
 Glass door slider.
 - 6 piece pack



01FE0050
 Glass door stainless steel slider.



01GM0001
 Adhesive gasket for glass leaf.
 - 6 m pack

accessories



31PE0004

Photoelectric sensor.
- IP64

99BA0004

Pre-wired emergency battery kit.

 other accessories available on page 100

operator cross-section
technical drawing

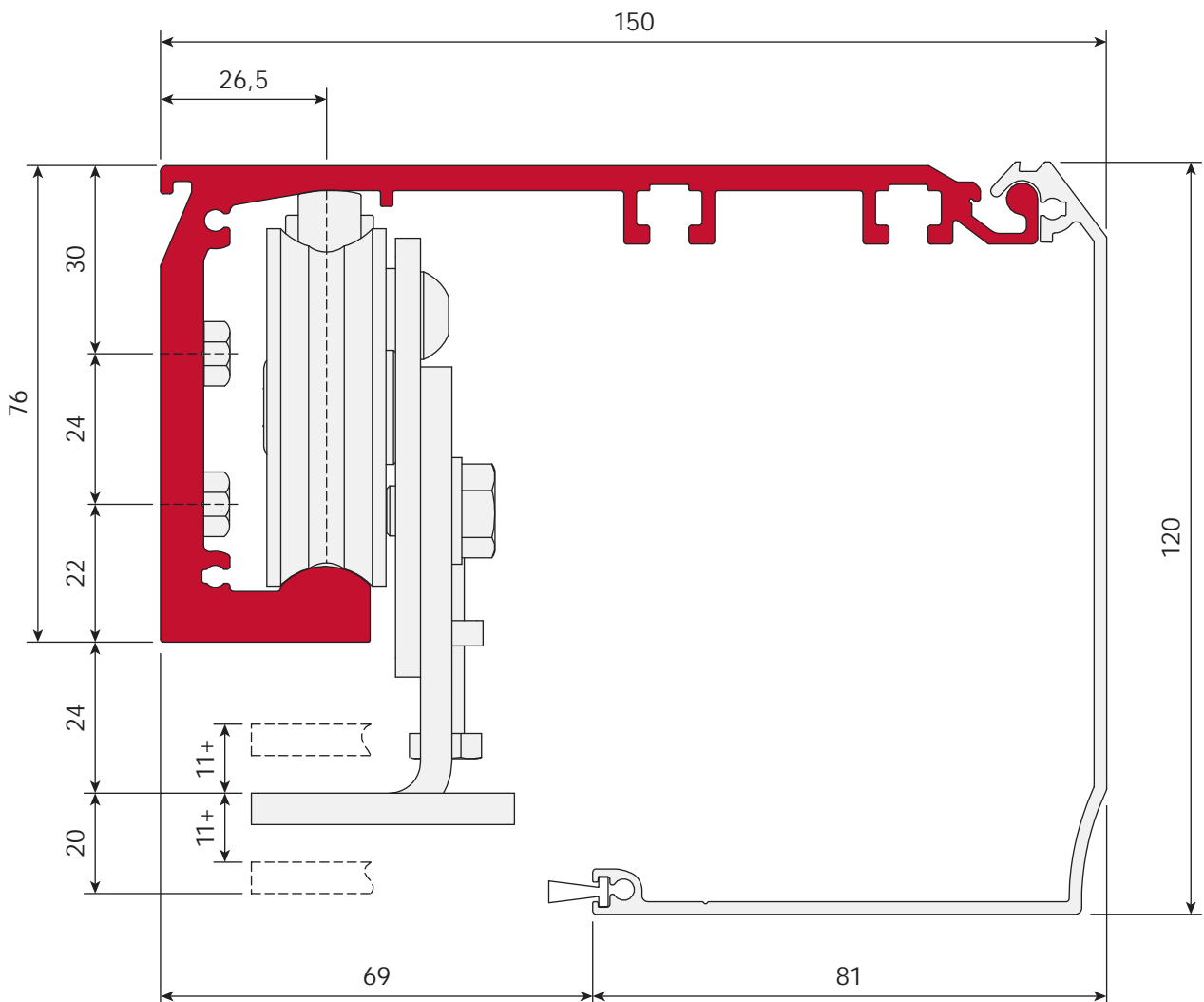

entrance with M30
myone frame

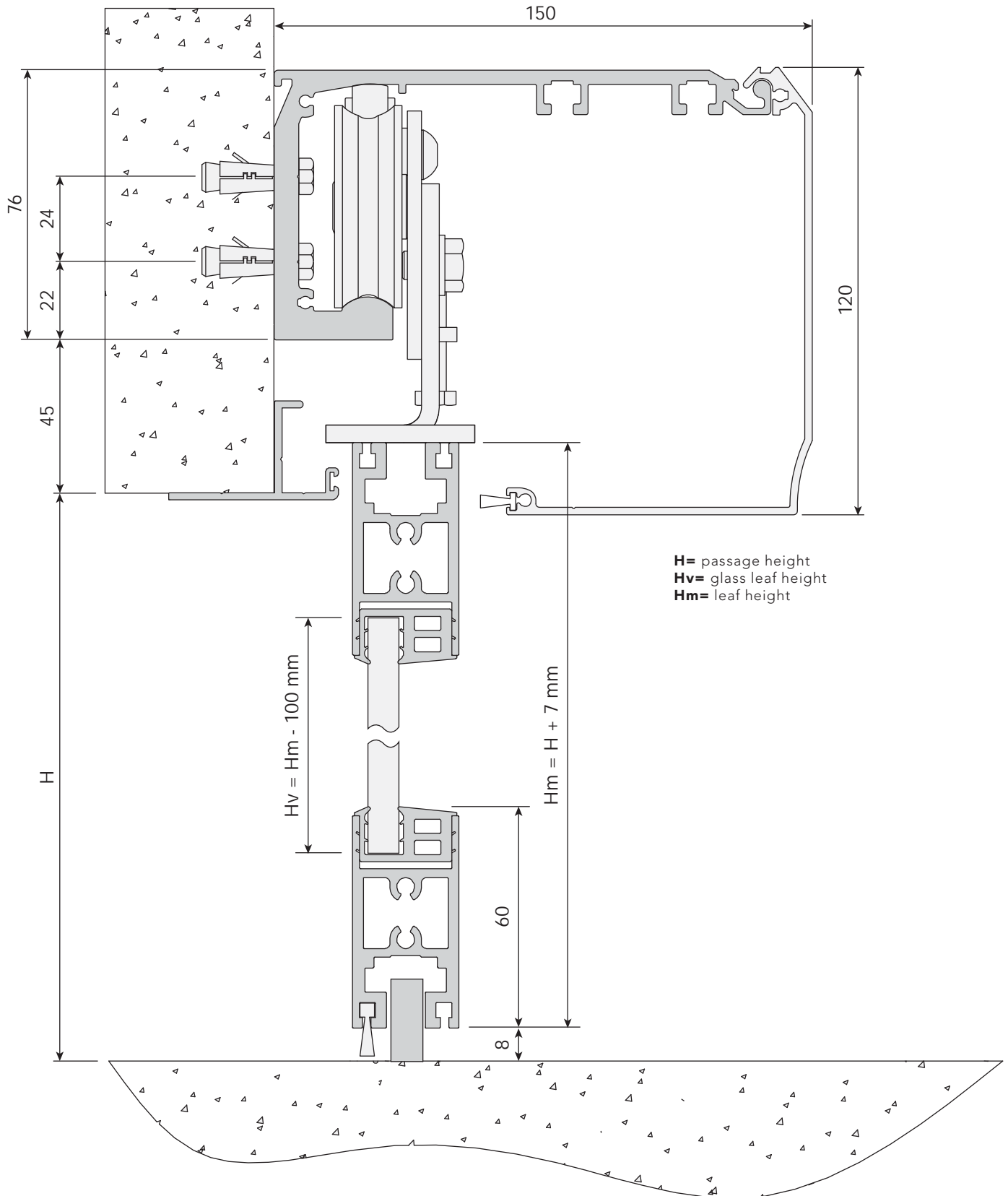

entrance with commercial profiles

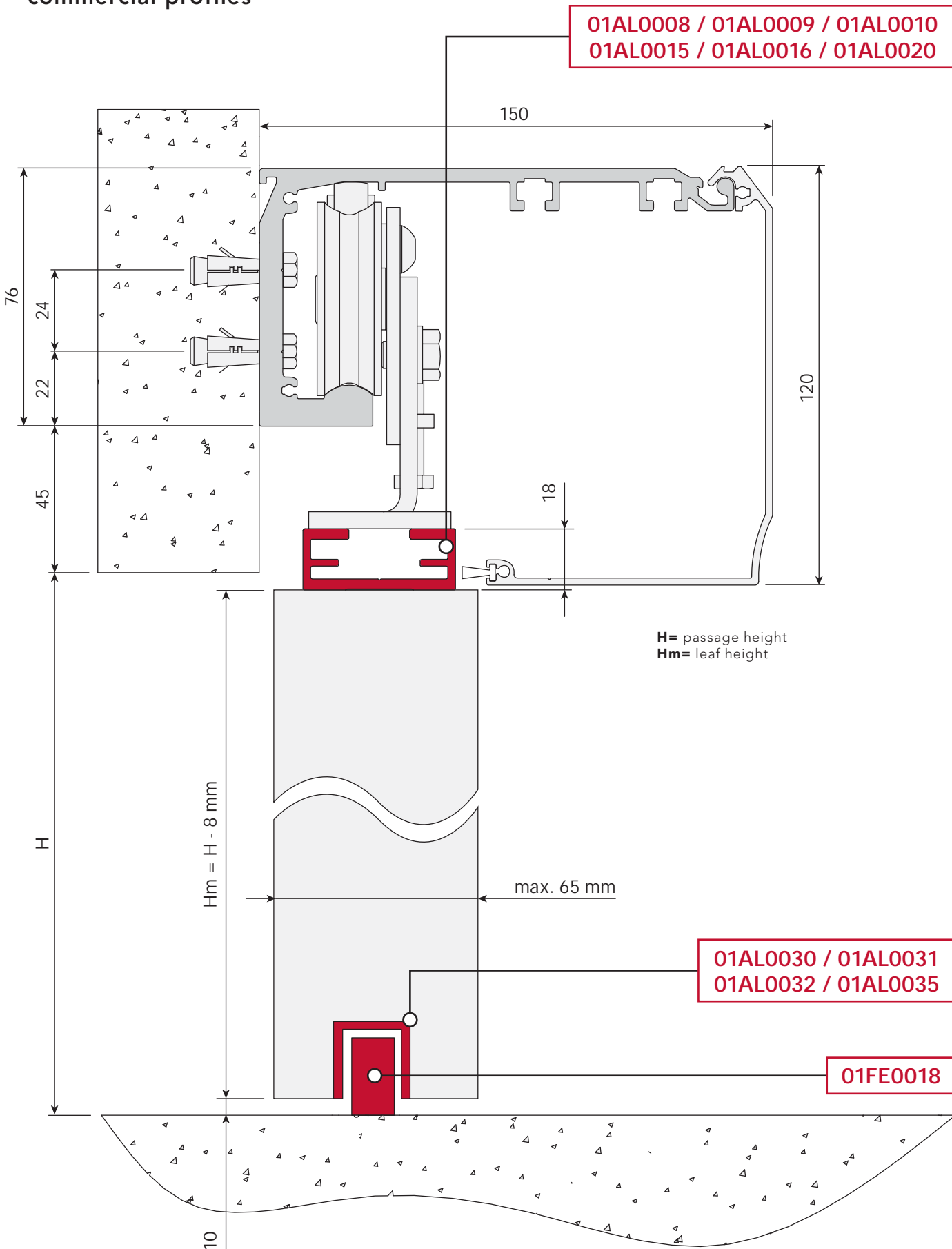

entrance with fastening set
for glass leaf with pre-drilled holes

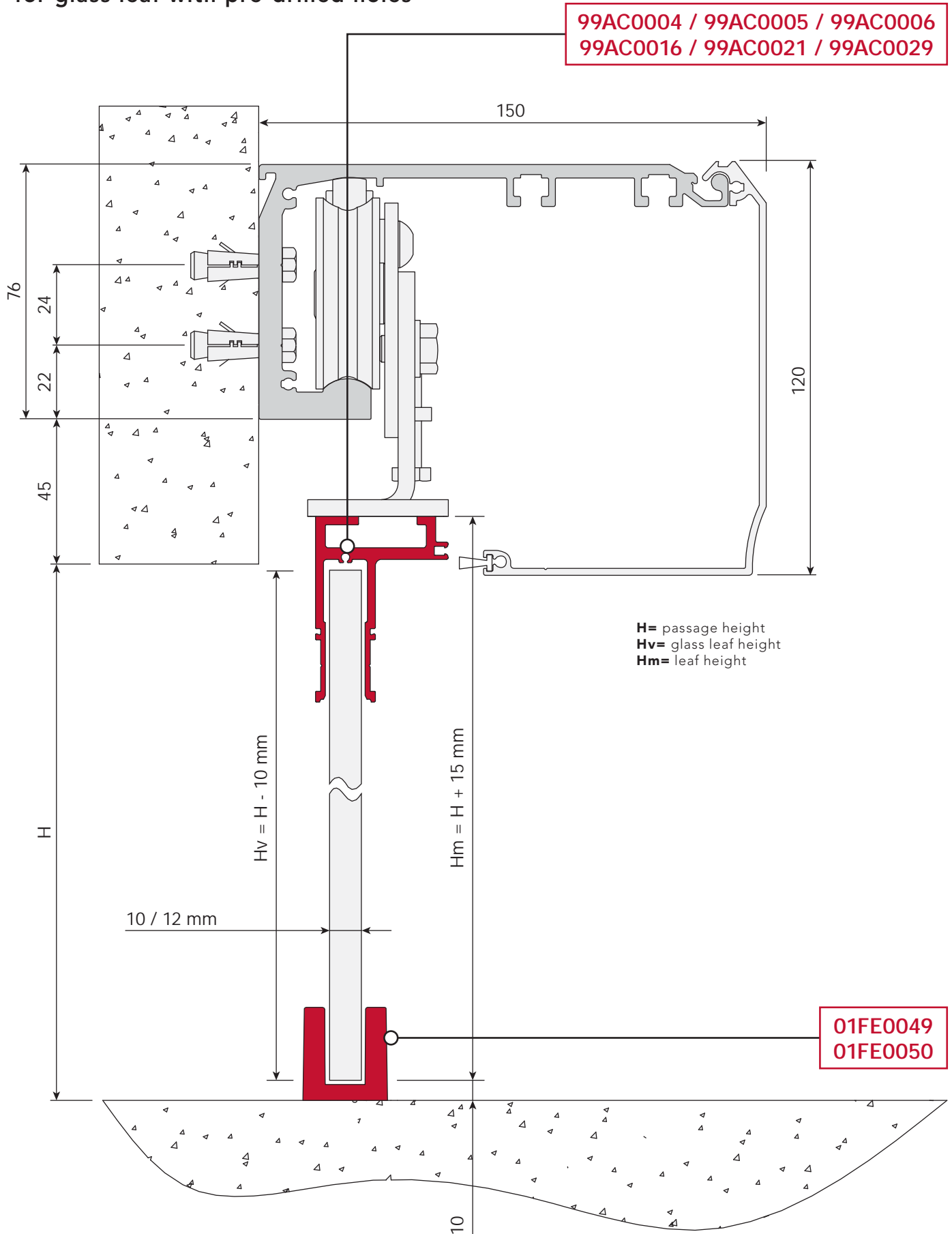

entrance with fastening set for glass leaf to clamp

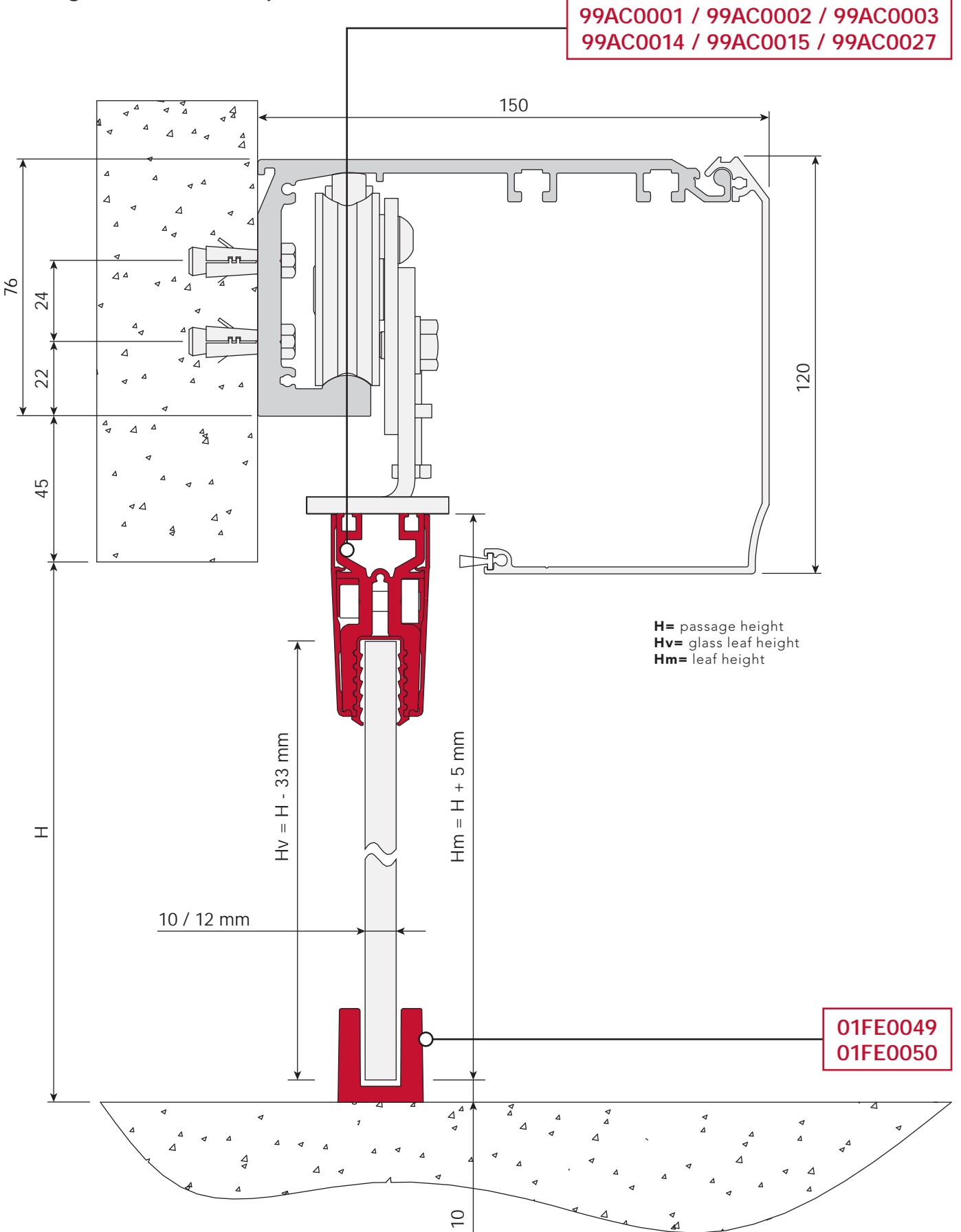



ARIA | ARIA S



swing
door

The operator models for swing doors, Aria and Aria S, can be used in public or private locations. The two versions meet two different requirements for use. Aria has an automatic opening and closure system, whereas the S model is distinguished by spring closing system.



ARIA | ARIA S



download ARIA | ARIA S
instructions
and certificates

www.myoneautomation.com

Aria has a new, elegant design with high aesthetic cleanness. It is an operator for single- or double-leaf swing doors and is ideal for continuous operation. It is available in a version with automatic opening and closing or with spring closing system (Aria S) and is recommended for public locations, such as hospitals or healthcare facilities, locations open to the general public such as hotels, offices, shops and banks, as well as in residential settings. It is activated using buttons, sensors and key-operated or rotating selectors.

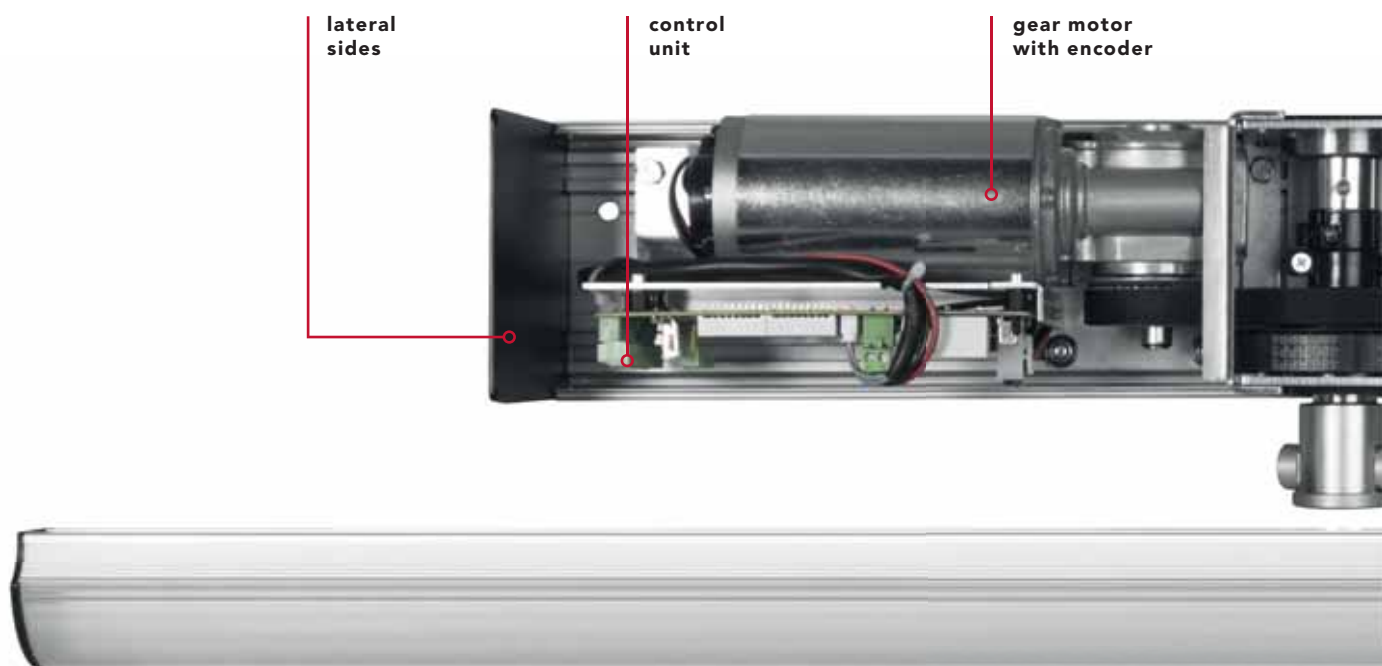

technical data



	ARIA	ARIA S
power supply	full range 100÷240 Vac 50/60 Hz	full range 100÷240 Vac 50/60 Hz
power consumption	70 W	70 W
power consumption in stand-by	3 W	3 W
accessories power supply	24 Vdc = / 1 A max	24 Vdc = / 1 A max
opening time	3÷12 s / 90°	5÷15 s / 90°
closing time	5÷12 s / 90°	6÷15 s / 90°
maximum torque	45 Nm	28 Nm opening 18 Nm closing
operation type	motor-driven opening motor-driven closing	motor-driven opening spring closing
type and frequency of use	continuous operation = 100%	continuous operation = 100%
operating temperature	-15°C / +50°C	-15°C / +50°C
protection degree	IP31	IP31
data backup memory	USB flash drive	USB flash drive



Various parameters can be selected, including the Push and Go function, which is essential whenever you want to activate automatic opening by an initial manual push. With its low-energy function, which enables the door to be opened with low energy and speed, Aria is particularly suited to settings where there are people with mobility problems.

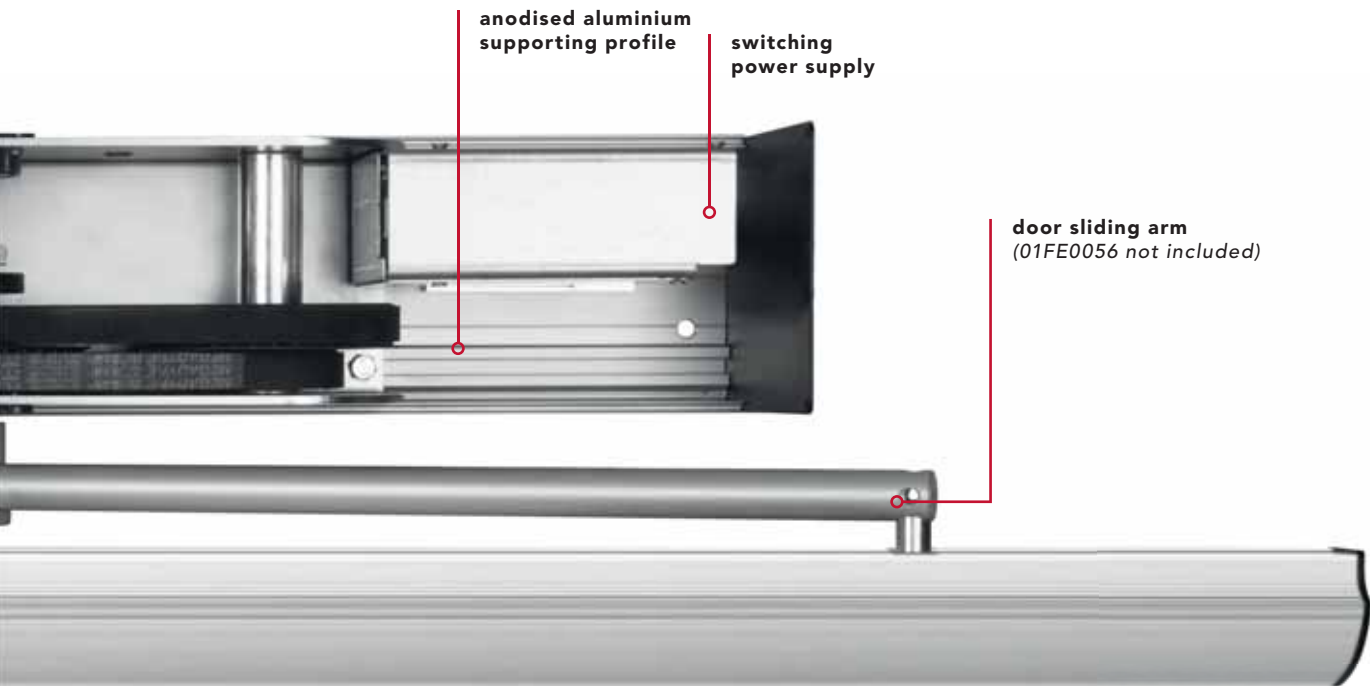

indications for use

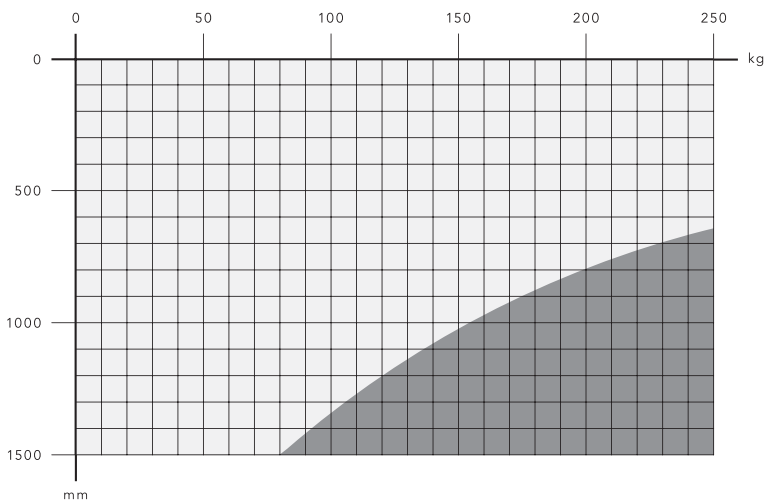

- recommended sizes
- use not permitted



swing door accessories

**01AL0024**

Joint guard for installing two operators for swing doors.
- L. 1000 mm

**01AL0025**

Joint guard for installing two operators for swing doors.
- L. 2000 mm

**01AL0026**

Joint guard for installing two operators for swing doors.
- L. 4000 mm

**01FE0054**

Extension for door arm attachment.

**01FE0055**

Door articulated arm to push.

**01FE0056**

Door sliding arm to pull.

**01FE0057**

Sliding elbow arm for swing leaf automation. Pull door. For lintel (120 mm).

**01FE0058**

Sliding elbow arm for swing leaf automation. Pull door. For lintel (220 mm).

**01FE0060**

Door sliding arm. Push door.

**31RS0001**

Swing door safety sensor (silver colour).
- EN16005
- IP54
- L. 350 mm

**31RS0002**

Swing door safety sensor (silver colour).
- EN16005
- IP54
- L. 900 mm

**31RS0005**

Safety sensor.
- IP52

**99CA0001**

Black cover for sensor 31RS0005.
- IP65

**31RS0006**

Safety sensor for right-hand swing doors.
- EN16005
- IP54

**31RS0007**

Safety sensor for left-hand swing doors.
- EN16005
- IP54

**31RS0008**

Safety sensor for a pair of swing doors.
- EN16005
- IP54

**31IB0001**

3 position rocker-switch.

**99BA0004**

Pre-wired emergency battery kit.

 other accessories available on page 100



operator technical drawing

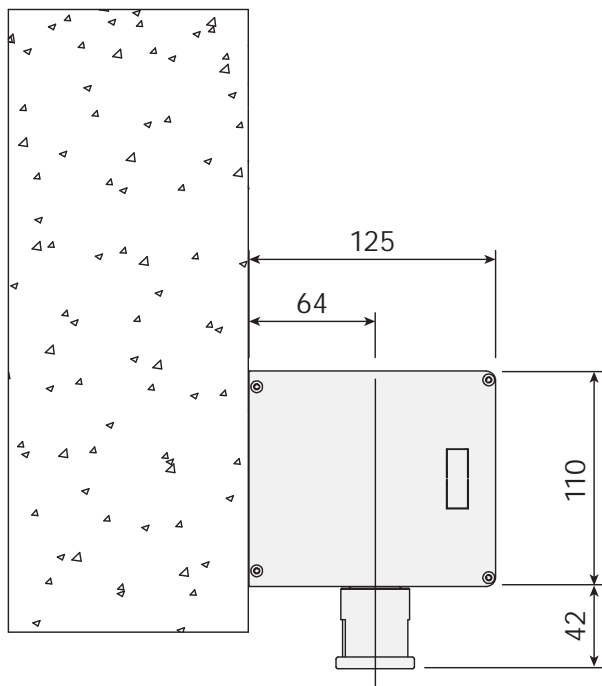
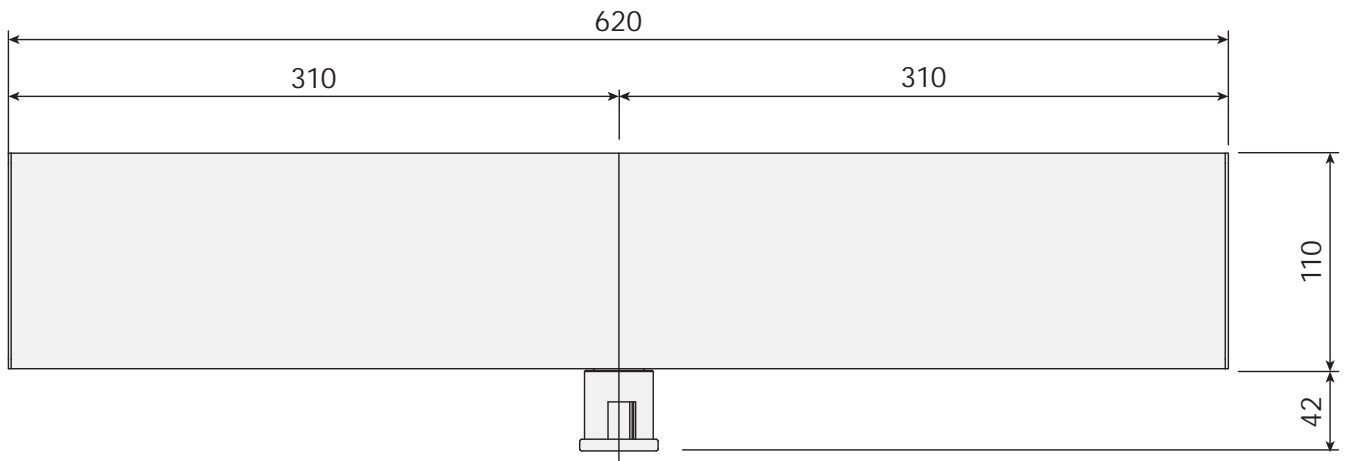



SLIDING AND SWING DOOR ACCESSORIES



**command, control
and safety electronic system**



SLIDING AND SWING DOOR ACCESSORIES

sensors



31RD0001

Opening and safety autotest sensor.
- EN16005
- IP54



99KR0001 - IP65
99KR0002 - IP54

Ceiling sensor assembly kit for 31RD0001/2 and 31RP0001.



99CA0002
Rain-proof cover for 31RD0001/2.



31RP0001
Sensor for side protection.
- EN16005
- IP54



31RM0002
Bidirectional microwave sensor.
- IP54



31RM0003
Unidirectional microwave sensor.
- IP54



31RS0005
Safety sensor.
- IP52



99CA0001
Black cover for sensor 31RS0005.
- IP65



31RS0001
Swing door safety sensor (silver colour).
- EN16005
- IP54
- L. 350 mm



31RS0002
Swing door safety sensor (silver colour).
- EN16005
- IP54
- L. 900 mm



31RD0003
Opening and safety autotest sensor.
- EN16005
- IP54



99KR0003
Ceiling sensor assembly kit for 31RD0003/4.



99CA0003
Rain-proof cover for 31RD0003/4.



31RP0002
Sensor for side protection.
- EN16005
- IP54



31RM0004
Unidirectional microwave sensor.
- IP54



31RS0006
Safety sensor for right-hand swing doors.
- EN16005
- IP54



31RS0007
Safety sensor for left-hand swing doors.
- EN16005
- IP54



31RS0008
Safety sensor for a pair of swing doors.
- EN16005
- IP54



31TX0001
BEA sensor programming remote control.



selectors and controls



AQA

Digital programmer/selector with LCD screen.



AQA.R

Digital selector device for Luce R.



AQA.CARD

Transponder card with NFC technology.
- 10 piece pack



315R0009

Rotary selector for sliding door.
- IP54



315R0010

Key-operated rotary selector for sliding door.
- IP54



315R0011

Rotary selector for swing door.
- IP54



315R0012

Key-operated rotary selector for swing door.
- IP54



315T0005

Touchless opening control, cable powered.
- IP65



315T0006

Touchless opening control, cable powered.
- IP65



315T0007

Touchless lock command, cable powered.
- IP65



31PE0001

Green emergency stop button.
- IP67



31PE0002

N.O. mushroom pushbutton.
Ø 90 mm, black.
- IP66



31PE0003

N.C. self-holding emergency stop button, Ø 40 mm.
- IP65

receivers



ONE.2WB

Universal 2-channel 433.92 MHz receiver in box. Triple coding: Advanced Rolling Code, Rolling Code and Fixed Code. 512 storable codes.

transmitters



TO.GO2A

Two-channel 433.92 MHz transmitter with Advanced Rolling Code to guarantee maximum security due to the length of the transmitted code (128 bit).



SMART

Cover to turn TO.GO into a wall pushbutton panel without the need for expensive wiring work in the wall. - IP40



safety



99AS0003

Anti-panic kit breaking through movable leaf.



99AS0004

Anti-panic kit breaking through fixed leaf.

	99AS0003 Sliding leaf	99AS0004 Fixed Leaf
Maximum height	2400 mm <i>Note: The measurement includes the breakthrough profile height (800 mm).</i>	2400 mm
Maximum weight	120 kg x 0,8 m 	100 kg



32FT0701

Photocells.
- L. 7 m; TX + RX



99AD0001

Safety adhesive set.



99AD0002

Leaf decal.
- L. 1200 mm



other accessories



01GM0005P

Guard finish gasket.
- 50 m



01GM0005

Guard finish gasket.
- 1 m



31RZ0001

Relay kit.
Interface with other equipment.



99AS0002

Silver floor-lead deadbolt.
- 450 mm

support beam

LUCE automations with M30 fixture

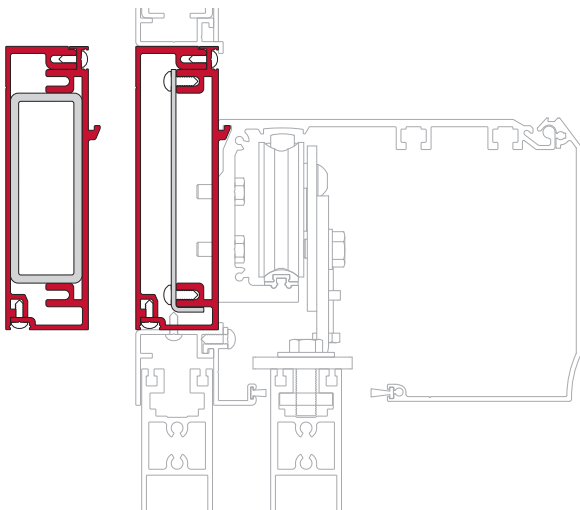

LUCE automations with generic fixture (requires 99KS0001)

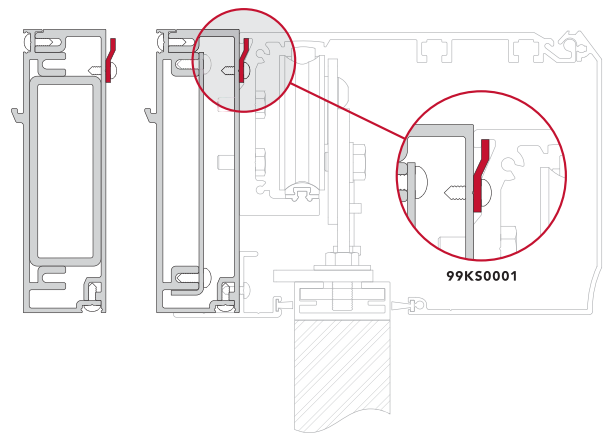

99PP3500

Anodised support beam for Myone automation.
- L. 3500 mm



99PP4200

Anodised support beam for Myone automation.
- L. 4200 mm



99PP6500

Anodised support beam for Myone automation.
- L. 6500 mm



KSFP

Support beam side fixing kit.

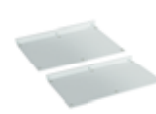

KSRP

Support beam reinforcement kit.



KSFT

Support beam tubular fixing kit.



01FE0061

Tubular reinforcement.
- L. 6000 mm



99KS0001

Casing suspension kit.

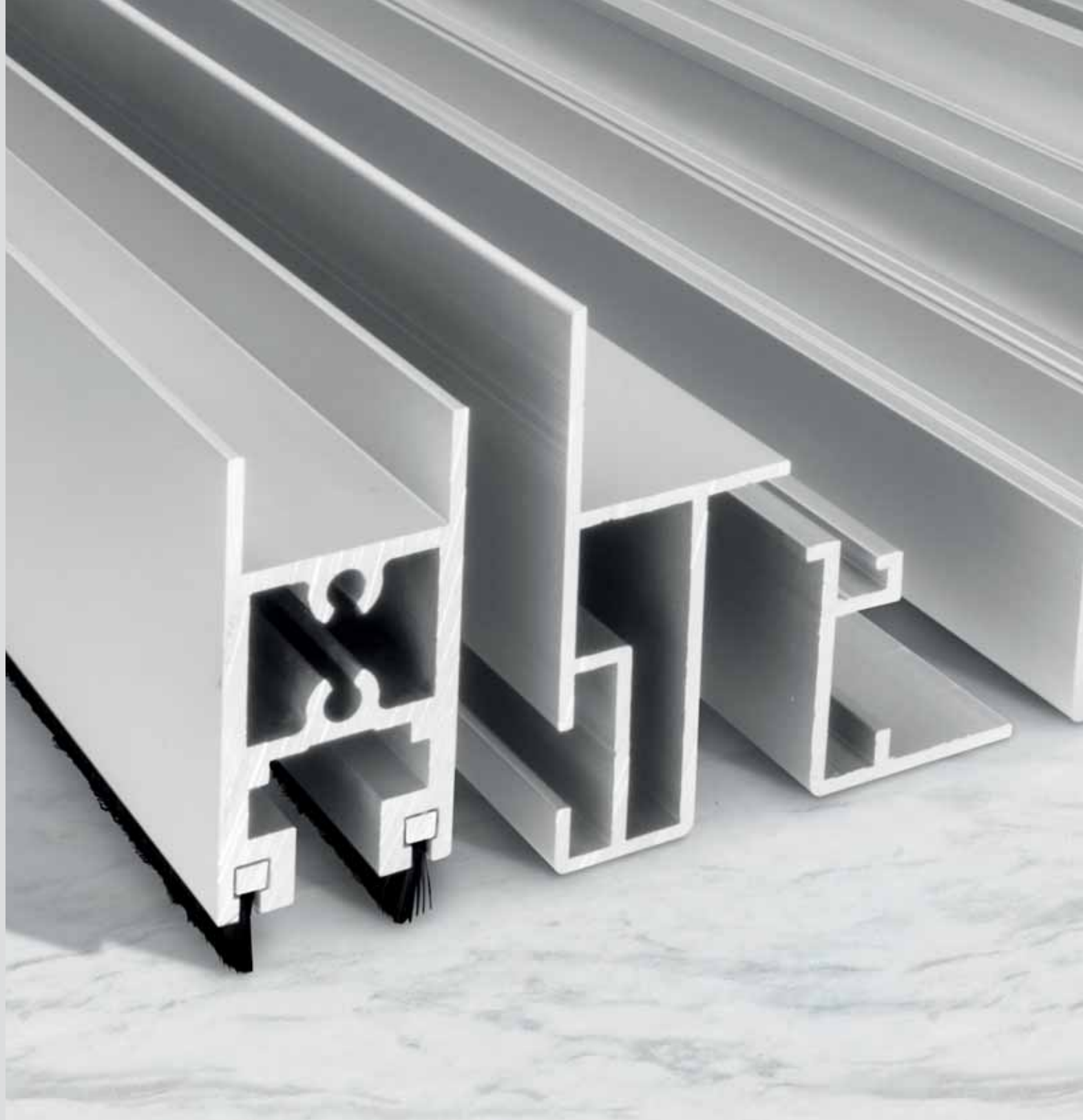

ALUMINIUM DOOR FRAMES



**myone
door frames**

www.myoneautomation.com

M30 is the frame series made of silver anodised aluminium to complete Myone automatic sliding doors. Profiles are characterised by a 30 mm thickness and can lodge two kinds of glass: 8-10 mm tempered/stratified glass and 20-22 mm double glazing. The frame series is available in complete kits and/or loose profiles with complementary accessories. In order to make the order of the correct codes easier, a configurator is available upon request, which allows obtaining the list of the components and the cutting size of the frame to realise.



SET OF COMPONENTS FOR SLIDING DOORS



M30K1

Set of components for 1 sliding door, opening to the right or left.
Maximum dimensions of wall opening: L=1530 mm, H=2990 mm

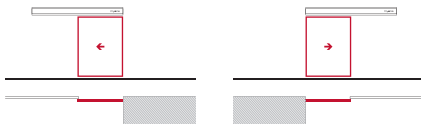

M30K1B

Set of components for 1 sliding door in a corridor, opening to the right or left.
Maximum dimensions of wall opening: L=1530 mm, H=2990 mm



M30K11

Set of components for 1 sliding door + 1 side wall, opening to the right or left.
Maximum dimensions of wall opening: L=3000 mm, H=3020 mm

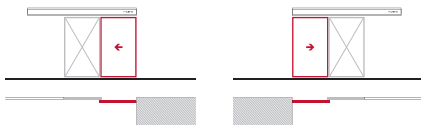

M30K11B

Set of components for 1 sliding door + 1 side wall in a corridor, opening to the right or left.
Maximum dimensions of wall opening: L=3000 mm, H=3020 mm

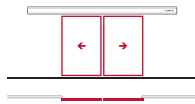

M30K2

Set of components for 2 sliding doors.
Maximum dimensions of wall opening: L=2060 mm, H=2990 mm

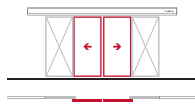

M30K22

Set of components for 2 sliding doors + 2 side walls.
Maximum dimensions of wall opening: L=4000 mm, H=3020 mm



M30K2T (Telescopic Door)

Set of components for 2 sliding doors, opening to the right or left.
Maximum dimensions of wall opening: L=1530 mm, H=2990 mm



M30K21T (Telescopic Door)

Set of components for 2 sliding doors + 1 side wall in a corridor, opening to the right or left.
Maximum dimensions of wall opening: L=3000 mm, H=3020 mm



M30K4T (Telescopic Door)

Set of components for 4 sliding doors.
Maximum dimensions of wall opening: L=2060 mm, H=2990 mm

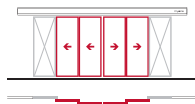

M30K42T (Telescopic Door)

Set of components for 4 sliding doors + 2 side walls.
Maximum dimensions of wall opening: L=4000 mm, H=3020 mm



aluminium profiles:

- ① M30A1 ② M30A2 ③ M30A3 ④ M30A4 ⑤ M30A5 ⑥ M30A6
- ⑦ M30A7 ⑧ MA30202A60 ⑨ MA50302A60 ⑩ MA302A60

seals and brushes:

- Ⓐ M30GR1 Ⓑ M30GR2 Ⓒ M30GR10 Ⓓ M30GR22 Ⓔ MAB4811 Ⓕ MAB415

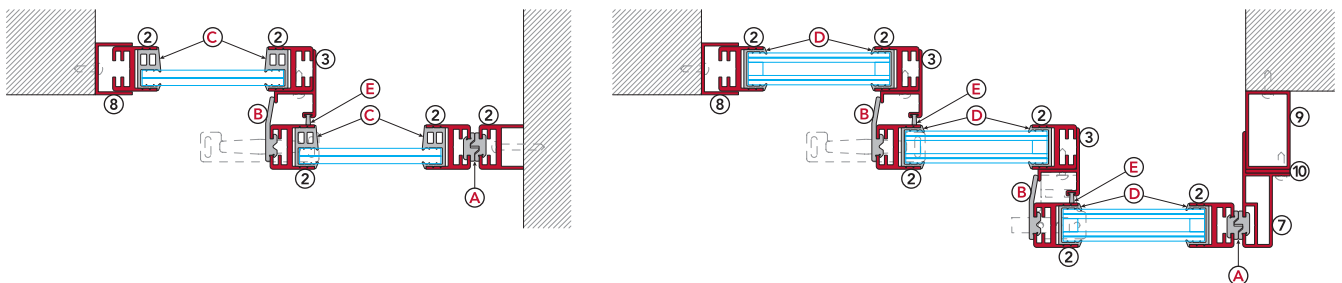
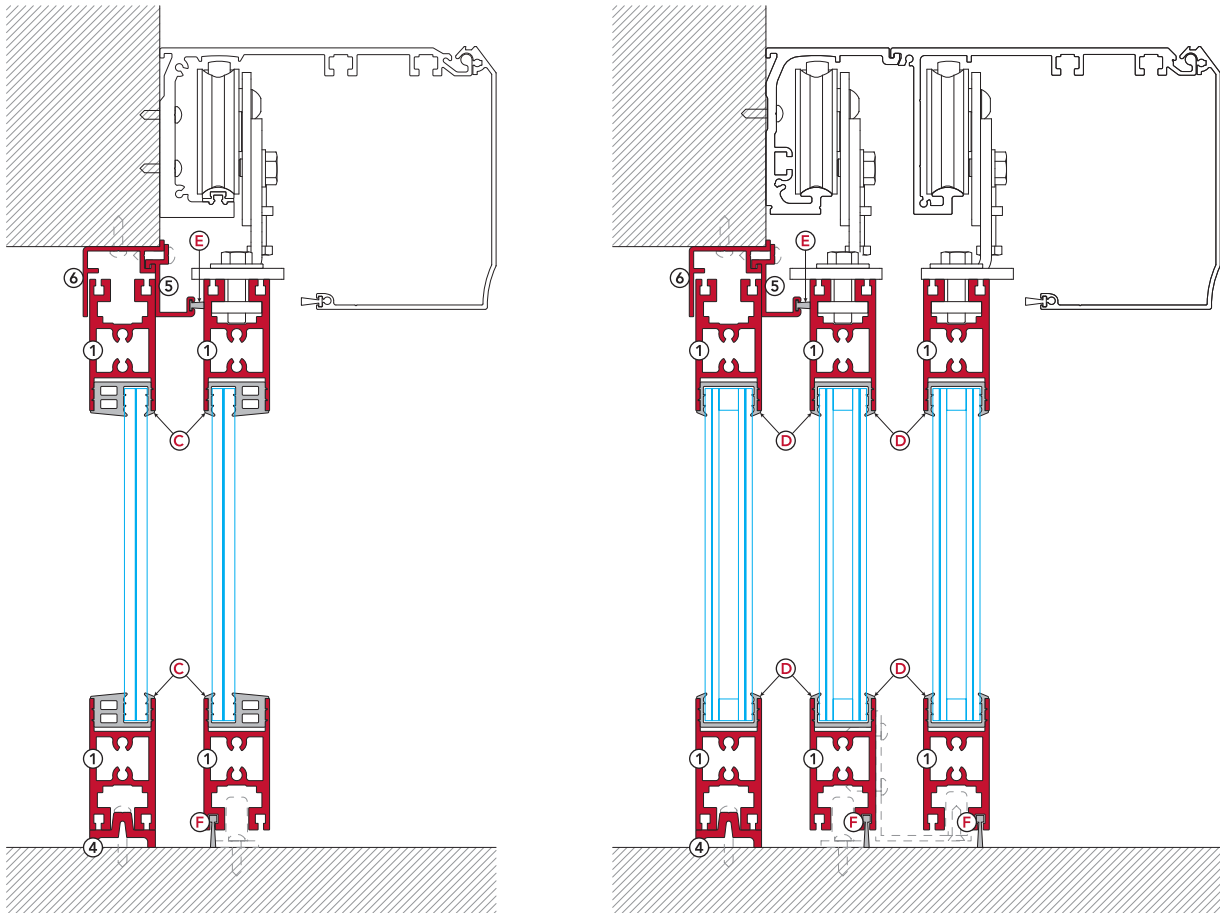













FANLIGHT COMPONENT SET

M30KFL1: Maximum fanlight dimensions: L=3000 mm, H=1000 mm







M30KFL2: Maximum fanlight dimensions: L=6000 mm, H=1000 mm

aluminium
profiles

profiles	cod.	description
	M30A1	Horizontal profile, silver anodised aluminium. <i>Bar 6.03 m, weight 1.634 kg/m.</i>
	M30A2	Vertical profile, silver anodised aluminium. <i>Bar 6.03 m, weight 0.766 kg/m.</i>
	M30A3	Frame profile, silver anodised aluminium. <i>Bar 6.03 m, weight 0.454 kg/m.</i>
	M30A4	Bottom floor profile, silver anodised aluminium. <i>Bar 6.03 m, weight 0.503 kg/m.</i>
	M30A5	Top frame profile, silver anodised aluminium. <i>Bar 6.03 m, weight 0.357 kg/m.</i>
	M30A6	Top frame profile, silver anodised aluminium. <i>Bar 6.03 m, weight 0.493 kg/m.</i>
	M30A7	Single-door frame profile, silver anodised aluminium. <i>Bar 6.03 m, weight 1.045 kg/m.</i>
	MA30202A60	U-shaped profile, 30x20x2 mm, silver anodised aluminium. <i>Bar 6 m, weight 0.357 kg/m.</i>
	MA35252A60	U-shaped profile, 35x35x2 mm, silver anodised aluminium. <i>Bar 6 m, weight 0.428 kg/m.</i>
	MA50302A60	Tubular profile, 50x30x2 mm, silver anodised aluminium. <i>Bar 6 m, weight 0.855 kg/m.</i>
	MA302A60	Flat profile, 30x2 mm, silver anodised aluminium. <i>Bar 6 m, weight 0.162 kg/m.</i>
	MA50152A60	L-shaped profile, 50x15x2 mm, silver anodised aluminium. <i>Bar 6 m, weight 0.340 kg/m.</i>



gaskets and brushes

	cod.	description
	M30GR1P	Close-side gasket, TPE 70 ShA. 50 m pack.
	M30GR1	Close-side gasket, 1 m.
	M30GR2P	Open-side gasket, TPE 70 ShA. 50 m pack.
	M30GR2	Open-side gasket, 1 m.
	M30GR10P	Gasket for 10 mm glass. 50 m pack.
	M30GR10	Gasket for 10 mm glass, 1 m.
	M30GR22P	Gasket for 22 mm glass. 50 m pack.
	M30GR22	Gasket Seal for 22 mm glass, 1 m.
	MAB4811P	Frame brush, 4.8x11 mm. 100 m pack.
	MAB4811	Frame brush, 4.8x11 mm, 1 m.
	MAB415	Bottom brush 4x15 mm. Bar 2.5 m.

assembly components

M30SET1	Bracket and screw kit for 1 sliding door, floor guide slider 01FE0018 included.	M30SET3	Bracket and screw kit for 1 telescopic door, floor guide slider 01FE0018T included.
M30SET2	Bracket and screw kit for 1 side wall.	M30SET4	Bracket and screw kit for 1 fanlight.



GALLERY











BENINCÀ GROUP

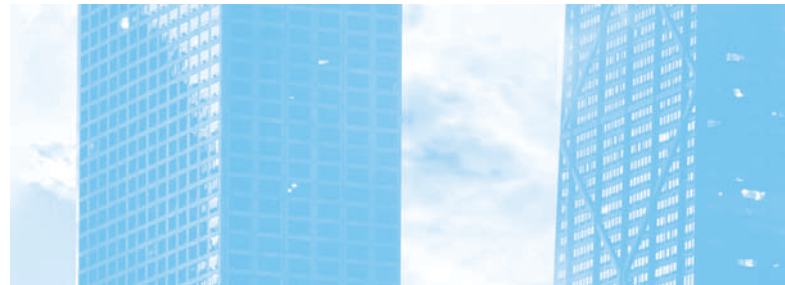
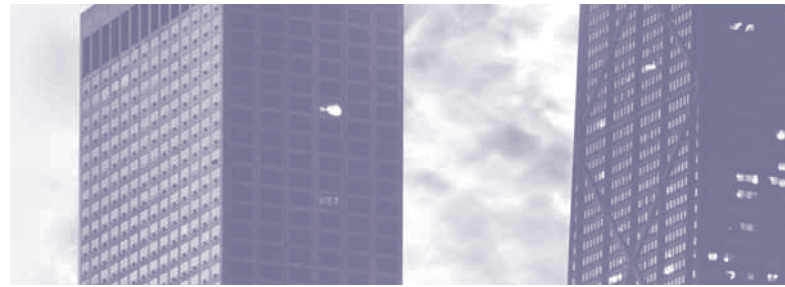

Benincà Group is made up of six companies specialising in the manufacture of systems for securing gates, doors and access points, in industrial and residential settings. The group was started 40 years ago when Automatismi Benincà was set up. Over the years, the Benincà Group's model of excellence has let to its products being taken across the world through 11 foreign branches and a network of specialist distributors. In 2009 five new companies were set up and the group was formed with the aim of offering customers and partners a comprehensive service through the production of complementary systems exploiting shared group expertise.

**BENINCA**
TECHNOLOGY TO OPEN

Automation devices for doors and gates for residential and industrial use, and traffic barriers.

**CAB**
MORE THAN AUTOMATION

Automation devices for shutters, hydraulic automation devices for gates, blinds and rolling shutters.

**HI**
MOTIONS
OPENING SOLUTIONS

Accessories for sliding gates, cantilever gates, swing gates and industrial doors.

**RISE**
Smart
Moving

Automatic, semi-automatic and fixed bollards, turnstiles and pedestrian access points.

SAVE YOUR ENERGY
BYOU

Automation system kits for residential use for gate automation.

**myone**

Automatic sliding and swing doors and electronic control accessories.



TERMS AND CONDITIONS OF SALE

These Terms of Sale apply to all Sales of Products, at the time of signing the contract or of confirming the order. If there is a conflict between these Terms and the conditions and terms agreed for an individual sale or in any existing commercial contract, the latter will prevail. MYONE shall not be bound by the General Terms of Purchase of the Customer in any circumstance, unless it has given prior consent in writing. MYONE has the right to modify any article in these Terms; any additions, modifications or cancellations shall apply to all sales concluded as from the thirtieth day after the official communication to Customers of the change made.

DEFINITIONS

- **MYONE:** the joint stock company MYONE S.r.l., in the person of its legal representative pro tempore, with head office in Italy, Quarto d'Altino (VE), Via Abbate Tommaso n. 52, P.IVA (IT) 04052150275.
- **CUSTOMER:** any subject (natural or legal person) who purchases the Products and who is not covered by the definition of Consumer according to the Consumer Code.
- **DATE OF DESPATCH:** the date of the transport document.
- **PARTIES:** means MYONE S.r.l. and the Customer.
- **PRODUCTS:** are the Products listed in the catalogue of MYONE, latest version, with the described technical specifications. It is stressed that all illustrative material is merely indicative. The Products may be modified or taken out of production by MYONE S.r.l. at any time.

1) PRICE OF THE PRODUCTS: The prices of the goods are those established in the price list in force at the time of order, which the Customer declares that he knows and accepts; the price list in force cancels all previous ones. MYONE S.r.l. may modify the price list; this modification will be notified to Customers and will be applicable to orders received as from the thirtieth day after said communication. MYONE always reserves the right to modify the price list unilaterally, if said modification is required by circumstances beyond its control: in this case the variation may take effect immediately.

2) TRANSPORT: The goods are sold ex works MYONE S.r.l. – Quarto d'Altino (VE), as the term is defined in the Incoterms of the International Chamber of Commerce, in the most updated version. The parties may choose a different term, with an agreement in writing; whatever term they choose, it will be interpreted according to the latest version of INCOTERMS®. The goods travel at the Customer's own risk, even if sent carriage paid. No complaints are accepted five days after receipt of the goods, even with reference to any difference in the products with respect to the type and quantity indicated in the order. A complaint within the term may not give rise to cancellation or reduction of the order by the Customer, nor to any payment of compensation of any kind by MYONE S.r.l. Any return of goods for credit must be authorised beforehand by MYONE S.r.l. and the goods must be sent carriage paid.

3) RETENTION OF OWNERSHIP: The products shall remain the property of MYONE S.r.l. until the date on which MYONE S.r.l. receives payment of the entire price of the products supplied. In performing his activity, the Customer shall have the right to sell these products, or new products in which the ones supplied by MYONE S.r.l. have been incorporated, in which case all the proceeds are to

be transferred to MYONE S.r.l., up to the amount of the price owed by the Customer for the supply of the products. MYONE S.r.l. shall have the right to notify the Customer of the revocation of the right to sell the Products in his possession and the ownership of which, under this clause of retention of ownership, has not yet passed to the Customer, if the Customer has remained in default for a period of more than seven working days with respect to the payment of any sum owed to MYONE S.r.l. (as regards both these Products and any other goods or services supplied to the Customer by MYONE S.r.l.). If MYONE S.r.l. exerts the right contemplated in the previous paragraph, the Customer must place the products at the disposal of MYONE S.r.l. who may access the Customer's premises to repossess them. While retention of ownership is pending, the Customer assumes the capacity, obligations and responsibilities of the keeper of the sold goods, according to art. 1766 and following articles of the Italian Civil Code. The Customer undertakes to fulfil all the obligations contemplated by the local laws to ensure that this clause of retention of ownership is valid and enforceable with third parties, making the required entries in any special register.

4) ORDERS: The order is received by MYONE S.r.l. without any commitment and subordinate to the possibility of supply of the raw materials necessary for production. Any total or partial non fulfilments cannot give rise to complaints and reserves for damages. If the Customer cancels specific orders for the production of Products not in the catalogue, he is required to pay MYONE S.r.l. compensation amounting to 30% (thirty per cent) of the cancelled order, without prejudice to the right to claim further damages. The orders regularly accepted by MYONE S.r.l. cannot be cancelled by the Customer without the consent of MYONE S.r.l. in writing. Please, it should be noted that MYONE S.r.l. will not accept orders for less than € 100,00 (EUR one hundred/00) VAT excluded, after discount and freight charges.

5) DELIVERY TERMS: The delivery terms run from receipt of the order and are expressed in terms of working days. They are indicative and not essential, according to art. 1457 of the Civil Code: consequently, any delays cannot give rise to claims for damages or to cancellation or reduction of the contract by the Customer.

6) FORCE MAJEURE: Besides those contemplated by the Italian Civil Code, the causes of force majeure that prevent the activity of the MYONE S.r.l. factory and justify delay or interruption of the fulfilment of contracts, relieving MYONE S.r.l. of the responsibility for delays or non delivery of products, also include the following, as an example without limitation: atmospheric events, earthquakes, fires, national, local or factory strikes, interruptions in transports and communications, scarcity of energy and of the necessary raw material. Breakdown of the machinery and production plants.

7) CONDITIONS OF PAYMENT: Payments must be made in Euro, with the terms and procedures indicated on the invoice. Payment in currency other than the Euro will be accepted only if agreed on beforehand in writing with MYONE S.r.l.. If the Parties agree on payment by irrevocable documentary letter of credit, the same will be accepted by MYONE if sent at least sixty days prior to the date of delivery of the Products and if confirmed by an Italian bank approved by MYONE. After the set payment time, MYONE S.r.l. may ask the Customer to pay interest due at the rate established by Legislative Decree 231/02. Once 5 (five) days have passed after the invoice falling due without payment having been made, MYONE



S.r.l. may suspend the execution and/or delivery of all other orders and cancel any similar sale or contract that may have been signed at that moment with the Customer. Any such measures undertaken by MYONE S.r.l. do not give the Customer any right to claim compensation for damages.

8) GUARANTEE: MYONE S.r.l. offers a conventional guarantee with a duration of 30 months from the date of production marked on the product itself. After 30 months the Customer expressly renounces the right of recourse concerning the legal guarantee with respect to MYONE S.r.l., according to art. 131 of the Consumer Code. This right, if exerted within the terms, will not, however, be recognised if the conformity defect depends on incorrect installation by the Customer. It is pointed out that the legal guarantee does not cover all the further circumstances that cannot be attributed to defects in manufacture and/or conformity of the goods. Moreover, in no case can the Customer activate the guarantee if the price of the products has not been paid within the terms and on the conditions agreed or if he is in default, even with reference to other orders or products, with respect to MYONE S.r.l.. By activating the conventional guarantee, the customer may request the repair or replacement of the product, on which free repair or replacement is guaranteed, at the discretion of MYONE S.r.l. , respecting the terms of this guarantee and of the legal requirements. Any defects found must be promptly communicated to MYONE by registered letter with recorded delivery and within the terms indicated by law. In no case does either the legal or the conventional guarantee cover defects due to: negligence or carelessness in use, wear (e.g. failure to follow the instructions for operation of the product or lack of maintenance), installation or maintenance carried out by non authorised personnel, or in an incorrect way and/or not conforming with the instructions; damage during transport, tampering with the product (for example, removal of the labels), tampering with documentation, external agents, undersized product or incorrect product choice. The products that do not fall under these guarantee conditions may be sent to MYONE S.r.l. , who may decide to repair or replace the goods according to the repair price list in force. The individual part repaired under or out of guarantee will be covered by a further guarantee period of 6 months.

9) RESPONSIBILITY: MYONE S.r.l. shall not be responsible for damage resulting from defects in the products, save in the case of malice or gross negligence. Moreover, any responsibility shall derive only and absolutely from the provisions of Italian law. MYONE S.r.l. shall not answer for more than the limit of liability of the Product Risk Insurance policy taken out by the company. MYONE S.r.l. shall not be responsible for indirect damage such as, purely as an example, loss of earnings of the Customer.

10) INTELLECTUAL PROPERTY RIGHTS: The brands of which MYONE S.r.l. is the owner or licence-holder, the patents, the designs or models, the know-how, the technical specifications and data of the products, the domain names containing the brand, are the total and exclusive property of MYONE S.r.l.. The Customer recognises the ownership of these rights by MYONE S.r.l. and undertakes to use them only according to the specific indications of MYONE S.r.l. and in the exclusive interest of the latter, and exclusively for the duration of the contractual relationship between the parties, without this giving the Customer any right or claim. The Customer undertakes not to register, appropriate or ask for protection for any intellectual property right belonging to MYONE S.r.l.. In particular,

he undertakes not to register and declares that he has not registered the brands and domain names.

11) EXPRESS TERMINATION CLAUSE: Pursuant to and in accordance with art. 1456 of the Italian Civil Code, MYONE S.r.l. may terminate the existing contract with the Customer in the case of non fulfilment of the obligations contained in the articles **7) Terms of Payment** and **10) Intellectual property rights**, of these terms of sale. Moreover, MYONE may terminate the existing contract with the Customer with immediate effect in the following cases: **a)** if the Customer is subject to insolvency proceedings or winding up, or if the state of the Customer's economic conditions is such as to lead it reasonably to be presumed that the Customer is insolvent; **b)** if the shares and/or quotas representing the majority or the control of the capital of the Customer are directly or indirectly transferred, assigned or held in escrow.

12) APPLICABLE LAW AND JURISDICTION: The obligations deriving from the relations between MYONE S.r.l. and the Customer, these terms of sale and all the contracts (unless expressly stated otherwise in writing) are regulated by the Italian Civil Code and by Italian law. For any dispute and controversy concerning these general terms of sale or deriving from the contractual relationship between MYONE S.r.l. and the Customer, the exclusive competent court shall be the Court of Vicenza, without affecting the faculty of MYONE S.r.l. to protect its rights by referring the litigation to any Court that it thinks fit.

13) PROCESSING OF PERSONAL DETAILS: Informed pursuant to Art. 13 of the European Regulation 679/2016, the Customer shall agree that personal data will be treated for purposes related to the business activity and the contractual obligations currently in force (as an example, consultation, usage, statistical processing, communication to companies contractually bound to MYONE S.r.l. etc.). The data controller is MYONE S.r.l. in the person of its legal representative. Procedures shall be implemented to process the said data so as to guarantee security and confidentiality. The Customer is entitled to receive information about the treatment of personal data, its modality and purposes, and request amendment, correction and/or integration, and cancellation of said data. Personal data shall be communicated to third parties in Italy or abroad for purposes of fulfilling the above-mentioned objectives. The complete regulation can be consulted on the webpage <http://www.myoneautomation.com/privacy.html>

14) INTERPRETATION OF THE TEXT: The Italian text of these general terms of sale, even if drawn up in several languages, will be the only authentic text for the purpose of their interpretation.



<https://www.myoneautomation.com/privacy.html>



OFFERING GUIDE

To be returned to:
sales@myoneautomation.com

Company Name*:

Name / Surname*:

Address*:

E-mail address*:

Project Reference:

Telephone:

Configuration*:

- Automation only
- Automation + Standard leaf fastening device
- Automation + Movable Leaf
- Automation + Glass leaf, fastening set with pre-drilled holes
- Automation + Movable Leaf + Fixed Leaf
- Automation + Glass leaf, fastening clamp set

Number of automations required*:

Opening Type (from the automation side)*:

Application in a corridor

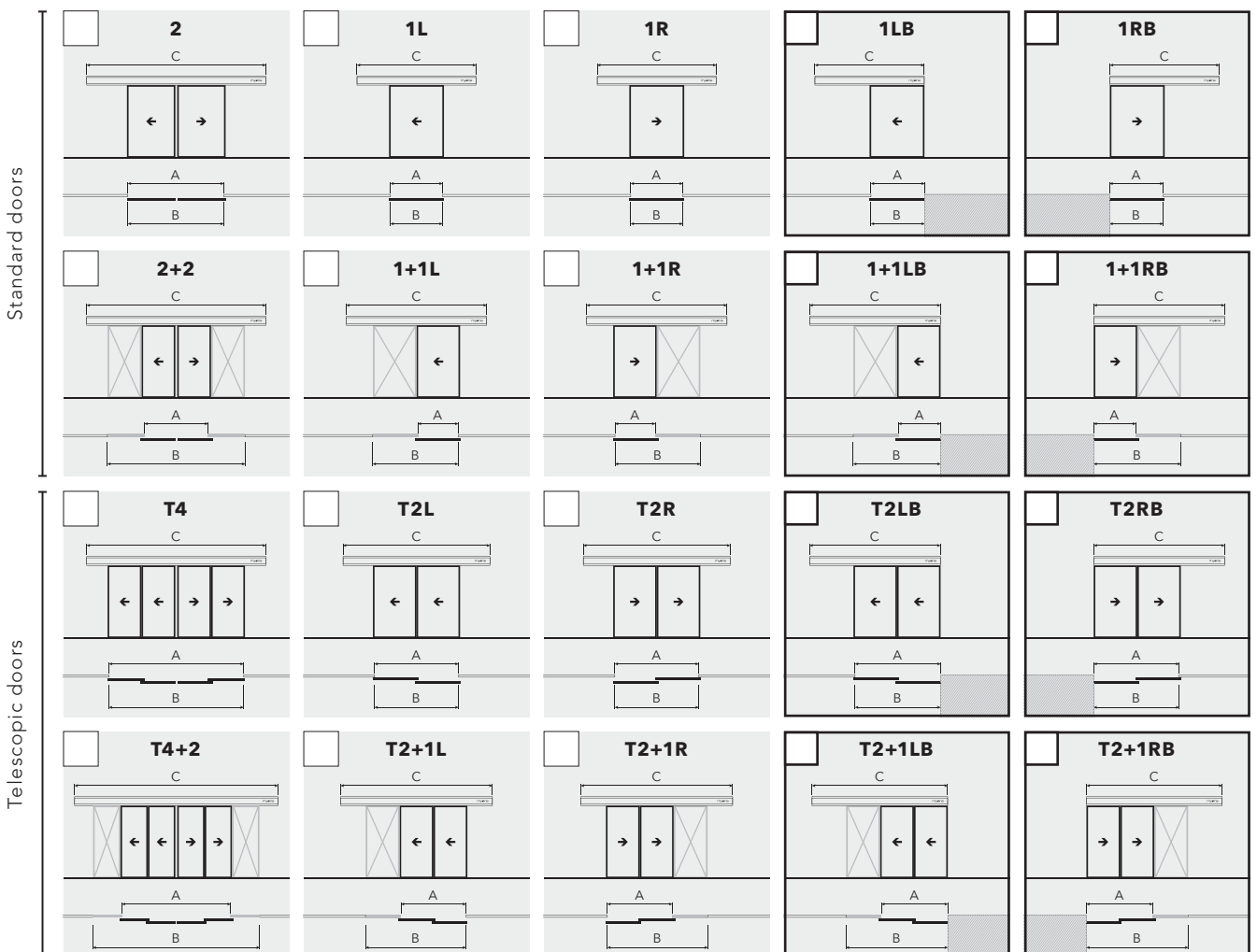

A: Width of the Passage Size | B: Width of the wall opening | C: Length of the Supporting Profile

Movable leaf weights (if available) [kg]

Width of the Passage Size* [mm]

Height of the Passage Size [mm]

Width of the wall opening [mm]

Length of the Supporting Profile [mm]

Automation finish*: Silver anodised aluminium Semi-gloss paint (Specify RAL): _____

Glass type*: Without 44.2 Double glazing More (specify thickness in mm): _____

Emergency Exit (if required):

- Anti-panic system with elastic
- Anti-panic system breaking with movable leaf
- Anti-panic system breaking with movable leaf + fixed leaf
- Certified Automation TUV LUCE R (Redundant Automation)

Control accessories:



31SR0009
Rotary selector

Specify quantity: _____



31SR0010
Key-operated selector

Specify quantity: _____



AQA
Selector/
Digital Programmer

Specify quantity: _____



AQA.R
Digital selector device for LUCE R

Specify quantity: _____

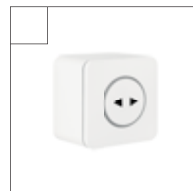

31ST0005
Touchless opening control, cable powered

Specify quantity: _____

Accessories:

- Opening and safety autotest sensor (31RD0001).
Specify quantity: _____
- Opening and safety autotest sensor (31RD0003).
Specify quantity: _____
- Sensor for side protection (31RP0001).
Specify quantity: _____
- Sensor for side protection (31RP0002).
Specify quantity: _____
- Bidirectional microwave sensor (31RM0002).
Specify quantity: _____
- Bidirectional microwave sensor (31RM0004).
Specify quantity: _____
- Photocells (32FT0701).
Specify quantity: _____
- Electromechanical lock kit.
Specify quantity: _____
- Emergency battery kit.
Specify quantity: _____
- Floor guide slider.
Specify quantity: _____
- Aluminium floor guide.
Specify quantity: _____

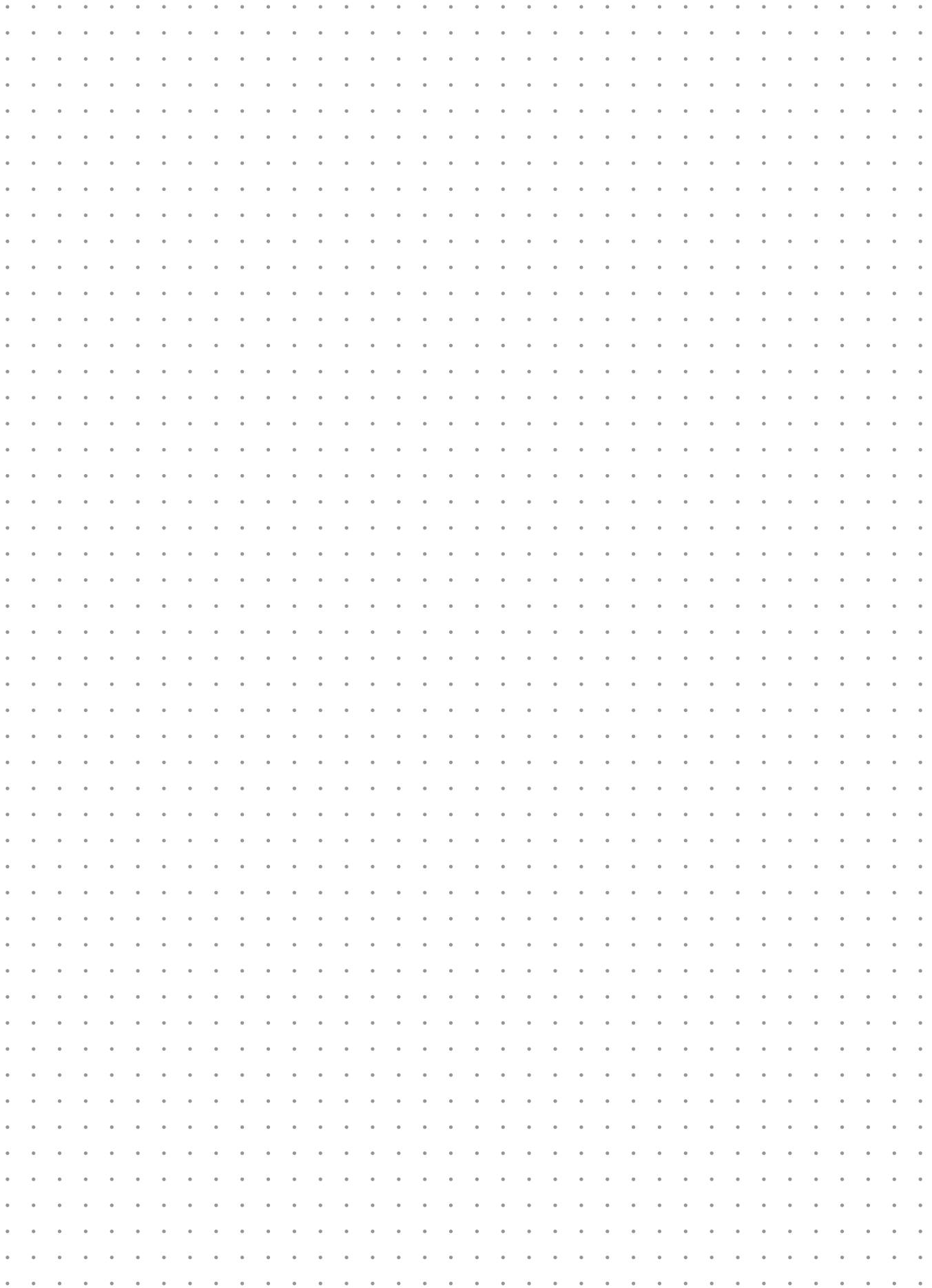

myone

MYONE Srl

Via Abbate Tommaso, 52
30020 Quarto D'Altino (VE) ITALY

T +39 0422 824384

info@myoneautomation.com
www.myoneautomation.com

751500083_10-22-03

Part of the Benincà family

BENINCA
GROUP